

# TOSHIBA



## HDD & DVD / VIDEO CASSETTE RECORDER

# RDXV60KB

## OWNER'S MANUAL



### For Customer Use:

Carefully read the Model No. and Serial No. located at the back of the unit and enter the information below. Retain this information for future reference.

Model No. \_\_\_\_\_

Serial No. \_\_\_\_\_

Introduction

Connections

Basic Setup /  
TV View Operation

Recording

Playback

Editing

Function Setup

VCR Functions

Others

# Introduction

## Precautions

**WARNING:** TO REDUCE THE RISK OF FIRE OR ELECTRIC SHOCK, DO NOT EXPOSE THIS APPLIANCE TO RAIN OR MOISTURE.



**CAUTION**

**RISK OF ELECTRIC SHOCK**

**DO NOT OPEN**



**CAUTION:**

TO REDUCE THE RISK OF ELECTRIC SHOCK, DO NOT REMOVE COVER (OR BACK). NO USER SERVICEABLE PARTS INSIDE. REFER SERVICING TO QUALIFIED SERVICE PERSONNEL.

The important note is located on the rear of the cabinet.



The lightning flash with arrowhead symbol, within an equilateral triangle, is intended to alert the user to the presence of uninsulated "dangerous voltage" within the product's enclosure that may be of sufficient magnitude to constitute a risk of electric shock to persons.



The exclamation point within an equilateral triangle is intended to alert the user to the presence of important operating and maintenance (servicing) instructions in the literature accompanying the appliance.

 The symbol for CLASS II (Double Insulation)

## Laser Safety

This unit employs a laser. Only qualified service personnel should remove the cover or attempt to service this unit, due to the possibility of eye injury.

**CAUTION:** USE OF CONTROLS OR ADJUSTMENTS OR PERFORMANCE OF PROCEDURES OTHER THAN THOSE SPECIFIED HEREIN MAY RESULT IN HAZARDOUS RADIATION EXPOSURE.

**CAUTION:** VISIBLE AND INVISIBLE LASER RADIATION WHEN OPEN AND INTERLOCK DEFEATED. DO NOT STARE INTO BEAM.

**LOCATION:** INSIDE, NEAR THE DECK MECHANISM.

## Power Supply

The power supply is connected and the unit is live when the mains cable is plugged into a 220 - 240 V~, 50 Hz AC outlet. To operate the unit, press [I/⏻ ON/STANDBY].

**WARNING: LIVE PARTS INSIDE.**  
**DO NOT REMOVE ANY SCREWS.**

## Caution

1. Do not attempt to open the cabinet. There are no parts inside you can service. Refer all servicing to qualified service personnel.
2. Slots and openings in the cabinet at the sides and underneath are provided for ventilation. To ensure reliable operation and to protect the unit from overheating, these openings must not be blocked or covered. Avoid installation in enclosed spaces such as bookcases unless suitable ventilation is provided.
3. Keep the unit away from radiators and other heat sources.
4. Avoid use near strong magnetic fields.

5. Do not push objects of any kind into the unit through the cabinet slots or openings as they could touch electrically live parts or short circuit parts resulting in a fire or electric shock.
6. To prevent fire or shock hazard, do not expose this apparatus to dripping or splashing, no objects filled with liquids, such as vases, should be placed on the apparatus.
7. Do not stand the unit vertically. Use the unit in a horizontal (flat) position only.
8. Before attempting to operate the unit, make sure that the timer recording mode is off.
9. This product is in Stand-by mode when turned off while the mains cable is connected.  
**The front panel display will not light up. This is a Power Saving Mode (ECO) for standby.**
10. Do not place any combustible objects on the device (candles, etc.).
11. Before moving the unit, be sure to remove any media and unplug the mains cable from the AC outlet.
12. Disconnect the mains plug to shut off the unit, if you suspect a fault has developed, or if it will not be used for an extended period.
13. The mains plug shall remain readily operable.
14. Read the instruction manual, and QSG to ensure correct and safe installation and interconnection of the unit in multimedia systems.
15. Keep a distance of 20 cm around the ventilation openings of the apparatus.

### A NOTE ABOUT RECYCLING

This product's packaging materials are recyclable and can be reused. Please dispose of any materials in accordance with your local recycling regulations.

This product consists of materials which can be recycled and reused if disassembled by a specialised company.

**Following information is only for EU-member states:**

The use of the symbol indicates that this product may not be treated as household waste. By ensuring this product is disposed of correctly, you will help prevent potential negative consequences for the environment and human health, which could otherwise be caused by inappropriate waste handling of this product. For more detailed information about recycling of this product, please contact your local city office, your household waste disposal service or the shop where you purchased the product.

**Following information is only valid EU-member States:****Disposal of batteries and/or accumulators**

The crossed out wheeled dust bin symbol indicates that batteries and/or accumulators must be collected and disposed of separately from household waste. If the battery or accumulator contains more than the specified values of lead (Pb), mercury (Hg), and/or cadmium (Cd) defined in the Battery Directive (2006/66/EC), then the chemical symbols for lead (Pb), mercury (Hg) and/or cadmium (Cd) will appear below the crossed out wheeled dust bin symbol. By participating in separate collection of batteries, you will help to assure the proper disposal of products and batteries and thus help to prevent potential negative consequences for the environment and human health. For more detailed information about the collection and recycling programmes available in your country, please contact your local city office or the shop where you purchased the product.



Pb, Hg, Cd

**Make your contribution to the environment!!!**

- Exhausted batteries do not belong in the dustbin.
- You can dispose of them at a collection point for exhausted batteries or special waste.
- Contact your council for details.



Do not place the unit on the furniture that is capable of being tilted by a child and an adult leaning, pulling, standing or climbing on it. A falling unit can cause serious injury or even death.

**Connection to Power**

Before Switching on make sure that the voltage of your electricity supply is the same as that indicated on the rating plate.

**Mains Cord**

This appliance may be fitted with a non-rewireable plug. If it is necessary to change the fuse in a nonwireable plug the fuse cover must be refitted. Do not use the plug if the fuse cover is lost or damaged. If a replacement fuse cover cannot be found, the plug must be changed with another carrying the same value fuse.

It is important that the colour of the replacement fuse cover corresponds with the rating marking on the base of the plug. If the plug has to be changed because it is not suitable for your socket, or becomes damaged, it should be cut off and an appropriate plug fitted following the wiring instructions below. The plug removed must be disposed of safely as insertion into a 13A socket is likely to cause an electrical hazard.

For your own safety read the following instructions carefully before attempting to connect this unit to mains.

The wires in this mains lead are coloured in accordance with the following code:

BLUE=NEUTRAL, BROWN=LIVE

**Important**

As the colours of the wires in the mains lead of this appliance may not correspond with the coloured markings identifying the terminals in your plug, proceed as follows:

The wire which is coloured blue must be connected to the terminal which is marked with the letter N or coloured black. The wire which is coloured brown must be connected to the terminal which is marked with the letter L or coloured red. No connection is to be made to the earth terminal of the plug. If a 13 Amp (BS 1363) Plug is used, a 5 Amp Fuse must be fitted, or if any other type of Plug is used a 3 or 5 Amp Fuse must be fitted, either in the Plug or Adaptor, or on the Distribution Board.

Mains Supply: 220 - 240 V~ 50 Hz - AC only

Do not make any connection to the larger pin marked with the letter "E" or by the symbol  $\perp$  or coloured green or green and yellow.

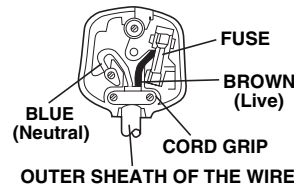
**Installation Location**

For safety and optimum performance of this unit:

- Install the unit in a horizontal and stable position.
- Keep the unit away from electronic equipment such as an amplifier, TV, etc. to prevent warping, damage, fire and malfunction.
- Do not place anything directly on top of the unit.
- Shield the unit from direct sunlight and keep away from sources of intense heat. Avoid dusty or humid locations. Avoid locations with insufficient ventilation for suitable heat dissipation. Do not block the ventilation holes on the sides of the unit. Avoid locations subject to strong vibration or strong magnetic fields.

**Avoid the Hazards of Electrical Shock and Fire**

- Do not handle the mains cable with wet hands.
- Do not pull on the mains cable to disconnect it from the AC outlet. Grasp it by the plug.
- If, by accident, water is spilled on the unit, unplug the mains cable immediately and take the unit to an authorised service centre for servicing.

**Moisture Condensation Warning**

Moisture condensation may occur inside the unit when it is moved from a cold place to a warm place, after heating a cold room, or under conditions of high humidity. Do not use the unit for at least 2 hours to allow the inside to dry.

**About Copyright**

Unauthorised copying, broadcasting, public performance and lending of discs are prohibited. This product incorporates copyright protection technology that is protected by U.S. patents and other intellectual property rights. Use of this copyright protection technology must be authorised by Macrovision, and is intended for home and other limited viewing uses only unless otherwise authorised by Macrovision. Reverse engineering or disassembly is prohibited.

## Notice for the Progressive Scan Outputs

Consumers should note that not all high definition television sets are fully compatible with this product and may cause artifacts to be displayed in the picture. In case of picture problems with 480 or 576 progressive scan output, it is recommended that the user switch the connection to the 'standard definition' output. If there are questions regarding your TV set compatibility with this 480p or 576p product, please contact our customer service centre.



Manufactured under license from Dolby Laboratories. Dolby and the double-D symbol are trademarks of Dolby Laboratories.

"Dolby® Digital Stereo Creator enables consumers to create stereo DVD-Videos with stunning Dolby Digital sound tracks at home. The technology, when utilised instead of PCM recording, also saves recordable disc space, allowing for higher video resolution or extended recording time on each DVD. DVDs mastered using Dolby Digital Stereo Creator will play back on all DVD-Video players."

Note: This is true when the players are compatible with actual recordable DVD discs.



Manufactured under license under U.S. Patent #: 5,451,942 & other U.S. and worldwide patents issued & pending. DTS and the Symbol are registered trademarks and DTS Digital Out and the DTS logos are trademarks of DTS, Inc. Product includes software.  
© DTS, Inc. All Rights Reserved.



HDMI, the HDMI Logo, and High-Definition Multimedia Interface are trademarks or registered trademarks of HDMI Licensing LLC in the United States and other countries.



DivX®, DivX Certified® and associated logos are registered trademarks of DivX, Inc. and are used under license.



DVB is a registered trademark of the DVB Project

## EU Conformity Statement



"This product is marked with "CE" and complies therefore with the applicable harmonized European standards listed under the Low Voltage Directive 2006/95/EC, the EMC Directive 2004/108/EC and ErP Directive 2009/125/EC(2005/32/EC)."

Responsible for CE-marking is  
TOSHIBA INFORMATION SYSTEMS (U.K.) LTD, Toshiba Court, Weybridge Business Park, Addlestone Road, Weybridge, Surrey, KT15 2UL, United Kingdom

MPEG Layer-3 audio coding technology licensed from Fraunhofer IIS and Thomson.

THIS PRODUCT IS LICENSED UNDER THE MPEG-4 VISUAL PATENT PORTFOLIO LICENSE FOR THE PERSONAL AND NON-COMMERCIAL USE OF A CONSUMER FOR (i) ENCODING VIDEO IN COMPLIANCE WITH THE MPEG-4 VISUAL STANDARD ("MPEG-4 VIDEO") AND/OR (ii) DECODING MPEG-4 VIDEO THAT WAS ENCODED BY A CONSUMER ENGAGED IN A PERSONAL AND NON-COMMERCIAL ACTIVITY AND/OR WAS OBTAINED FROM A VIDEO PROVIDER LICENSED BY MPEG LA TO PROVIDE MPEG-4 VIDEO. NO LICENSE IS GRANTED OR SHALL BE IMPLIED FOR ANY OTHER USE. ADDITIONAL INFORMATION INCLUDING THAT RELATING TO PROMOTIONAL, INTERNAL AND COMMERCIAL USES AND LICENSING MAY BE OBTAINED FROM MPEG LA, L. L. C. SEE [HTTP://WWW.MPEGLA.COM](http://www.mpegla.com)

## Maintenance

### CLEANING THE UNIT

Use a soft cloth slightly moistened with a mild detergent solution. Do not use solutions containing alcohol, spirits, ammonia or abrasives.

### CLEANING DISCS

If a disc becomes dirty, clean it with a cleaning cloth. Wipe the disc from the centre out. Do not wipe in a circular motion. Do not use solvents such as benzene, thinners, commercially available cleaners, detergent, abrasive cleaning agents or antistatic spray intended for analogue records.

### DISC HANDLING

Handle the discs so that fingerprints and dust do not adhere to the disc surfaces.

Always store the disc in its protective case when it is not in use.

### HDD HANDLING

- HDD is a precision apparatus that is susceptible to vibration, strong impact or dirt. Depending on the installation environment or handling, the unit may become partially damaged or in the worst case, recording or replaying may not be available. Especially while the HDD is in motion, do not subject it to vibration or strong impact or pull out the power plug. And if a power failure occurs, the content of the recording / replaying programme may be lost.
- HDD rotates at high speed when in operation. Be sure that rotation has stopped and then move the unit without subjecting it to strong impact or vibration.

### SERVICING

If the unit becomes inoperative, do not try to correct the problem by yourself. There are no user serviceable parts inside. Turn the unit off, unplug the mains cable, and consult your dealer or an authorised service centre.

### CLEANING THE DISC LENS

If the unit does not perform correctly even though you have referred to "Troubleshooting" and the relevant sections in the Owner's Manual, the laser optical pickup unit may be dirty. Consult your dealer or an authorised service centre for inspection and cleaning of the laser optical pickup unit.

## AUTO HEAD CLEANING

- Automatically cleans video heads as you insert or remove a cassette, so you can see a clear picture.
  - Playback picture may become blurred or interrupted while the TV programme reception is clear. Dirt accumulated on the video heads after a long period of use, or the usage of rental or worn tapes can cause this problem. If a streaky or snowy picture appears during playback, the video heads in the unit may need to be cleaned.
- Please visit your local Audio / Video store and purchase a good quality VCR Video Head Cleaner.
  - If a Video Head Cleaner does not solve the problem, please consult your dealer or an authorised service centre.

### Note

- Remember to read the instructions along with the video head cleaner before use.
- Clean video heads only when problems occur.

## Accessories Supplied

- Remote control with 2 R6 (1.5 V) batteries
- RF cable
- Owner's Manual
- Quick Setup Guide
- Helpline Sheet

## Features

The following features are available with this unit.

### Recording

HDD

DVD

VCR

- Recording up to 36 programmes (HDD/DVD)**
- One-touch timer recording:**  
(HDD/DVD) [➔ Page 32]  
(VCR) [➔ Page 74]

HDD

DVD

- Automatic chapter mark setting:** [➔ Page 31]
- Automatic Playlist making**

HDD

- 320 GB hard disc**
- PDC:** [➔ Page 34]

DVD

- Alternate recording:** [➔ Page 34]
- Automatic finalising:** [➔ Page 45]
- Automatic title menu making:** [➔ Page 45]

### Dubbing

HDD

DVD

- High speed dubbing:** [➔ Page 41]
- Auto recording mode dubbing:** [➔ Page 41]

HDD

DVD

VCR

- DV dubbing:**  
(HDD/DVD) [➔ Pages 39-40]  
(VCR) [➔ Page 75]

## Playback

HDD

DVD

- Theatre surround sound:** [➔ Page 19]
- Quick search:** [➔ Pages 54-55]
- Variable skip:** [➔ Page 51]
- Variable replay:** [➔ Page 51]
- Playback from Original or a Playlist:** [➔ Page 46]
- Virtual Surround System:** [➔ Page 57]
- Playing back data files recorded in a USB device:** [➔ Page 48]

HDD

- Chasing playback during recording and simultaneous playback and recording:** [➔ Page 53]
- Pausing a TV broadcast to resume later (Pause TV):** [➔ Page 53]

DVD

- Playing back MP3 / JPEG / DivX® files:** [➔ Pages 47-49]

VCR

- Quick search:** [➔ Pages 75-76]

## Editing

HDD

DVD

- Adding or deleting chapter marks manually:** [➔ Page 61]
- Creating titles to a Playlist:** [➔ Page 63]
- Deleting titles:** [➔ Page 59]
- Deleting a scene of a title:** [➔ Page 64]
- Editing title name:** [➔ Page 60]
- Combining titles:** [➔ Page 63]
- Dividing titles:** [➔ Page 62]
- Protecting titles:** [➔ Page 62]

DVD

- Adding or deleting chapter marks at once (video mode DVD-RW only):** [➔ Page 61]
- Hiding chapters:** [➔ Page 62]

## Compatibility

DVD

- Playing back discs recorded in video mode in any regular DVD player:** [➔ Page 45]

## Others

HDD

DVD

- Progressive scan system:** [➔ Pages 17, 71]
- HDMI (High-Definition Multimedia Interface):** [➔ Pages 18, 72]

Introduction

Connections

Basic Setup /  
TV View Operation

Recording

Playback

Editing

Function Setup

VCR Functions

Others













## Table of Contents

<b>Introduction .....</b>	<b>2</b>	<b>Editing .....</b>	<b>58</b>
Precautions .....	2	Guide to a Title List .....	58
Features .....	5	Editing Discs .....	59
Guide to the Owner's Manual .....	7	Deleting Selected Titles .....	60
Functional Overview .....	10	Deleting All Titles in HDD .....	64
Installing Batteries in the Remote Control .....	12		
Switching HDD / DVD / VCR mode .....	12	<b>Function Setup .....</b>	<b>65</b>
Guide to On-Screen Displays .....	13	General Setting .....	67
Front Panel Display Guide .....	16		
		<b>VCR Functions .....</b>	<b>74</b>
<b>Connections .....</b>	<b>17</b>	Playback .....	74
Connecting to a TV .....	17	Basic Recording and One-touch	
Connecting to External Equipment .....	19	Timer Recording (OTR) .....	74
Digital Audio for Better Sound Quality .....	19	Search .....	75
		Other Operations .....	76
<b>Basic Setup / TV View Operation .....</b>	<b>20</b>	Hi-Fi Stereo Sound System .....	76
Initial Setting .....	20		
Channel Setting .....	20	<b>Others .....</b>	<b>77</b>
TV View Operation .....	23	Troubleshooting .....	77
		Troubleshooting for Error Messages .....	80
<b>Recording .....</b>	<b>28</b>	Language Code .....	82
Information on DVD Recording .....	28	Specifications .....	83
Formatting a Disc .....	30		
Selecting the Audio Mode .....	31		
Basic Recording and One-touch			
Timer Recording (OTR) .....	32		
Timer Recording .....	33		
Timer Recording (EPG) .....	36		
Series Link Timer Recording .....	37		
Satellite Link .....	37		
Settings for External Equipment .....	38		
Information on DV Dubbing .....	39		
DVC to HDD / DVD Dubbing .....	40		
Information on Dubbing .....	40		
Setting a Disc to Protect .....	44		
Finalising Discs .....	45		
<b>Playback .....</b>	<b>46</b>		
Basic Playback .....	46		
PBC Function for Video CDs .....	50		
Special Playback .....	51		
Search .....	54		
Repeat / Random / Programme Playback / Slide Show ...	55		
Selecting the Format of Audio and Video .....	56		

## Guide to the Owner's Manual

### Symbols Used in the Owner's Manual

To show what recording mode or media type applies to each function, the following symbols appear at the beginning of each operating item.

Symbol	Description
	Available to (internal) HDD
	Available to DVD-videos
	Available to DVD-RW discs in video mode
	Available to DVD-RW discs in VR mode
	Available to DVD-R discs in video mode
	Available to DVD+RW discs
	Available to DVD+R discs
	Available to audio CDs
	Available to video CDs
	Available to CD-RW/-R discs and USB device with MP3 files
	Available to CD-RW/-R discs and USB device with JPEG files
	Available to DVD-RW/-R, DVD+RW/+R, CD-RW/-R discs and USB device with DivX® files (DivX® files in USB device are not guaranteed.)
	Available to VHS tapes Use only cassettes marked VHS (VHS)

### Symbols for Tuner Setting and Recording

The following is the description for the symbols for tuner setting used in this manual.

**ANALOG** : Settings only for the analogue mode

**DVB** : Settings only for the DVB mode

Introduction

Connections

Basic Setup /  
TV View Operation

Recording

Playback

Editing

Function Setup

VCR Functions

Others

		Media for Recording / Playing							
Media Type		DVD-RW		DVD-R	DVD+RW	DVD+R	HDD		
Logo									
Format		Can be formatted in VR or video mode		Automatically formatted in video mode	Automatically formatted in +VR mode	Automatically formatted in +VR mode	-		
Icon		Video Mode 	VR Mode 						
Maximum Record Time		480 min (12 cm) 144 min (8 cm)	480 min (12 cm) 144 min (8 cm)	480 min (12 cm) 144 min (8 cm)	480 min (12 cm) 144 min (8 cm)	480 min (12 cm) 144 min (8 cm)	545 hrs (with SLP mode)		
Recordable/Playable Versions		1x-6x Ver. 1.1/1.2 Ver. 1.1/1.2 CPRM compatible		1x-16x Ver. 2.0/2.1	1x-4x	1x-16x	-		
Compatibility		Playable on most DVD players. Finalisation necessary. (Title menu will be created)	Playable only on VR mode compatible unit. Finalisation recommended.	Playable on most DVD players. Finalisation necessary. (Title menu will be created)	Playable on DVD+RW compatible players. Finalisation recommended. (Title menu will be created)	Playable on most DVD players. Finalisation recommended. (Title menu will be created)	-		
Available Features	<b>Recording Features</b>								
	Record TV Programmes	✓	✓	✓	✓	✓	✓	✓	
	Reuse by Deleting the Current Contents	✓	✓		✓		✓	✓	
	Record 16:9 Size Pictures	✓	✓	✓			✓	✓	
	Record Copy-once Programmes		✓*				✓	✓	
	Create Chapters at Fixed Intervals (auto chapter)	✓	✓	✓	✓	✓	✓	✓	
	<b>Editing Features</b>								
			Playlist	Original				Playlist	Original
	Scene Delete		✓	✓				✓	✓
	Edit Title Name	✓	✓	✓	✓	✓	✓	✓	✓
	Create Chapters Wherever You Like (chapter mark)		✓	✓		✓	✓	✓	✓
	Divide a Title		✓			✓		✓	✓
	Combine Titles		✓					✓	
	Hide Chapters					✓	✓		
	Delete a Title	✓	✓	✓	✓	✓	✓	✓	✓
Deleting Selected Titles							✓	✓	
Create a Playlist			✓					✓	
Protect a Title			✓					✓	

✓: Available

Grey: Not available

\* CPRM compatible disc only.



DVD players with **RW COMPATIBLE** are capable of playing DVD-RW recorded in VR mode.



Discs for Playing					
Disc Type	DVD-VIDEO	CD-DA	Video CD	CD-RW	CD-R
Logo					
Icon					

Files for Playing			
Type of title	MP3	JPEG	DivX®
Icon			
Media	CD-RW/-R USB device	CD-RW/-R USB device	CD-RW/-R DVD-RW/-R DVD+RW/+R USB device (not guaranteed)

- DVD** is a trademark of DVD Format/Logo Licensing Corporation.
- **ABOUT DIVX VIDEO:** DivX® is a digital video format created by DivX, Inc. This is an official DivX Certified device that plays DivX video. Visit [www.divx.com](http://www.divx.com) for more information and software tools to convert your files into DivX video.
  - **ABOUT DIVX VIDEO-ON-DEMAND:** This DivX Certified® device must be registered in order to play DivX Video-on-Demand (VOD) content. To generate the registration code, locate the DivX VOD section in the device setup menu. Go to [vod.divx.com](http://vod.divx.com) with this code to complete the registration process and learn more about DivX VOD.
  - DivX Certified® to play DivX® video, including premium content.
  - Media containing the DivX® files with the DivX® GMC (Global Motion Compensation) playback feature, which is DivX® supplemental function, cannot be played back on this unit.

### Unplayable Discs

The following discs will not play back on this unit.

- CD-ROM
  - Compact Disc-Interactive (CD-I)
- Video Single Disc (VSD)
- DVD-ROM
- DVD-audio
- Unfinalised disc
- DVD or CD contains Windows Media™ Audio files
- DVD-RW/-R recorded in non compatible recording format
- Blu-ray Disc
- HD DVD

On the following disc, the sound may not be heard.

- Super audio CD - Only the sound on the CD layer can be heard. The sound on the high-density super audio CD layer cannot be heard.

### Colour Systems

This unit uses the PAL system. However, it is also possible to play back DVDs using other colour systems, such as NTSC.

### Region Codes

This unit has been designed to play DVD with region 2. If these region symbols do not appear on your DVD, you cannot play back the DVD in this unit. The number inside the globe refers to region of the world.



Following discs are recommended for good recording quality and are proven to be compatible with this unit. However, depending on the media condition the unit may not read the disc properly.

Verbatim	DVD+R 8x, DVD+RW 4x, DVD-R 8x, DVD-RW 2x
JVC	DVD-RW 4x
Maxell	DVD+R 4x/8x/16x, DVD-R 8x/16x
SONY	DVD+R 4x/8x/16x, DVD+RW 4x
TDK	DVD+R 4x/8x/16x

Performance of any other discs are not guaranteed.

- Toshiba is not liable for any damage or loss caused directly or indirectly by the malfunction of this unit, including, without limitation, any one of the following:
  - Failure to record contents intended to be recorded by the consumer.
  - Failure to edit contents as intended by the consumer.
  - When a DVD-RW/-R, DVD+RW/+R disc created on this unit is used (e.g., insertion, playback, recording or editing) in another DVD player, recorder or personal computer drive.
  - When a DVD-RW/-R, DVD+RW/+R disc that is used in the manner described in the immediately preceding bullet point is used again in this unit.
  - When a DVD-RW/-R, DVD+RW/+R disc that was recorded in another DVD recorder, or in a personal computer drive is used in this unit.
- Some functions may not work with personal computer discs.
- Discs recorded in this unit may not operate as expected on other DVD players, recorders or personal computer drives.

Because of problems and errors that can occur during the creation of DVD and CD software and/or the manufacture of DVD and CD discs, Toshiba cannot guarantee that product will play every feature of every DVD bearing the DVD logo and/or every CD bearing the CD logo. As one of the creators of DVD technology, Toshiba DVD players are manufactured using the highest standards of quality, and as a result, such incompatibilities are rare.

## Functional Overview

### Front Panel

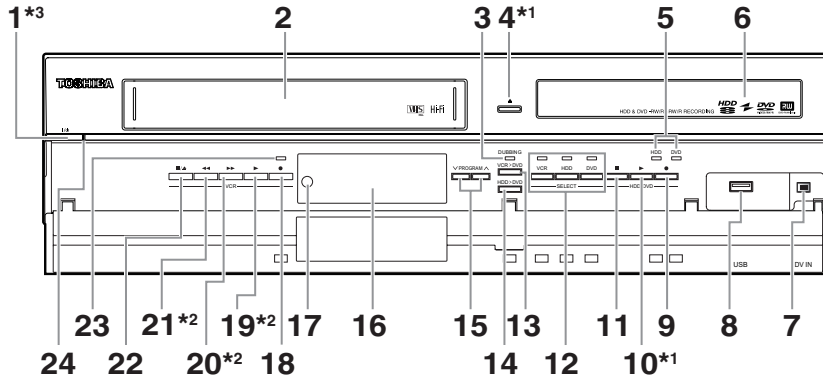

(★1) You can also turn on the unit by pressing these buttons.

(★2) You can turn on the unit by pressing these buttons only when a videotape is in this unit.

(★3) Press to turn on the unit, or to turn the unit into the standby mode. (To completely shut down the unit, you must unplug the AC power cord.)

- |   |                                      |
|---|--------------------------------------|
| 1 I/⏻ ON/STANDBY button <sup>★3</sup>               | 13 DUBBING VCR > DVD button          |
| 2 Cassette compartment                              | 14 DUBBING HDD > DVD button          |
| 3 DUBBING indicator                                 | 15 PROGRAM ^ / v buttons             |
| 4 ▲ OPEN/CLOSE button <sup>★1</sup> (DVD)           | 16 Display ("Off" in standby)        |
| 5 REC indicators (HDD/DVD)                          | 17 Infrared sensor window            |
| 6 Disc tray   | 18 ● REC button (VCR)                |
| 7 DV IN jack (AV3)                                  | 19 PLAY ► button <sup>★2</sup> (VCR) |
| 8 USB input jack                                    | 20 FWD ►► button <sup>★2</sup> (VCR) |
| 9 ● REC button (HDD/DVD)                            | 21 REV ◀◀ button <sup>★2</sup> (VCR) |
| 10 PLAY ► button <sup>★1</sup> (HDD/DVD)            | 22 STOP/EJECT ■ / ▲ button (VCR)     |
| 11 STOP ■ button (HDD/DVD)                          | 23 REC indicator (VCR)               |
| 12 Device select buttons / indicators (HDD/DVD/VCR) | 24 Power indicator                   |

#### Button names described in the Owner's Manual

The instructions in this manual are described mainly with the operations using the remote control. Some operations can be carried out using the buttons on the front panel.

### Rear Panel

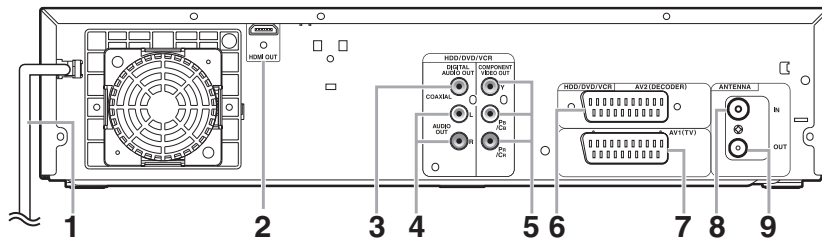

- |  |   |
|--|---|
| 1 Mains cable                                    | 5 COMPONENT VIDEO OUT jacks (HDD/DVD/VCR) |
| 2 HDMI OUT jack (HDD/DVD/VCR)                    | 6 AV2 (DECODER) socket (HDD/DVD/VCR)      |
| 3 DIGITAL AUDIO OUT (COAXIAL) jack (HDD/DVD/VCR) | 7 AV1 (TV) socket (HDD/DVD/VCR)           |
| 4 AUDIO OUT (L/R) jacks (HDD/DVD/VCR)            | 8 ANTENNA IN                              |
|  | 9 ANTENNA OUT                             |

#### Note

- Do not touch the inner pins of the jacks on the rear panel. Electrostatic discharge may cause permanent damage to the unit.
- After turning off the unit, leave the mains cable plugged for about one minute. Otherwise it may cause data loss or the unit may not work properly.
- **This unit does not have an RF modulator.**

## Remote Control

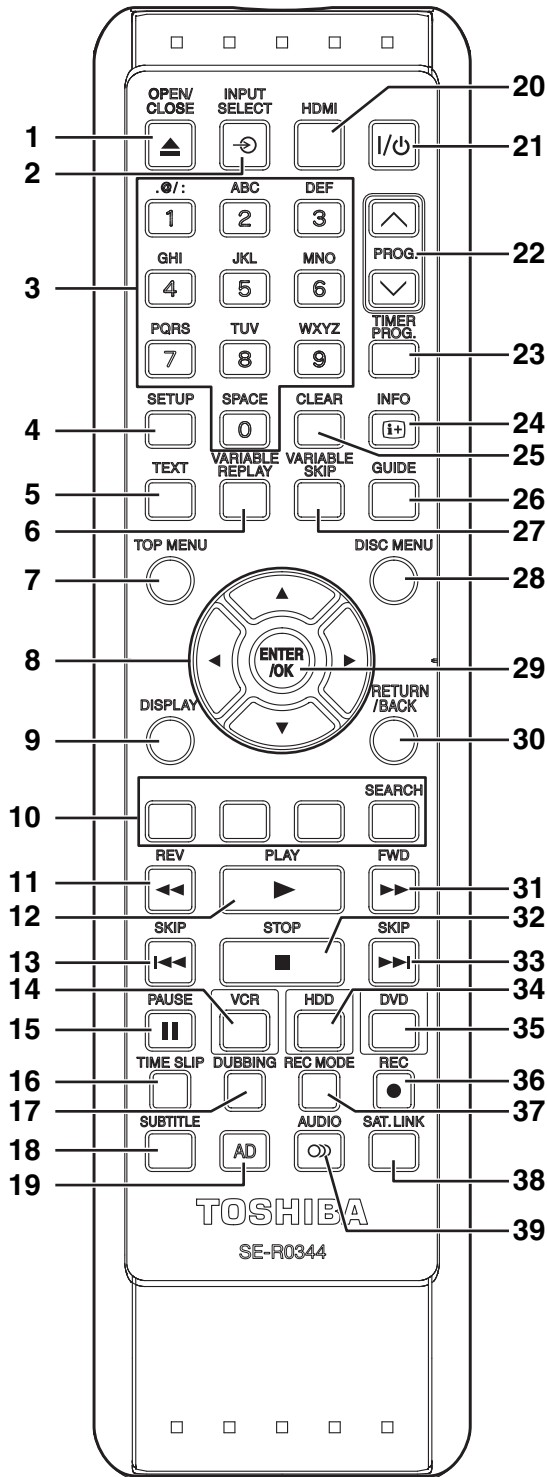

- 1 OPEN/CLOSE ▲ button (DVD/VCR)
- 2 INPUT SELECT ↻ button
- 3 Number buttons
- 4 SETUP button
- 5 TEXT button
- 6 VARIABLE REPLAY button (HDD/DVD)
- 7 TOP MENU button (HDD/DVD)
- 8 Direction ▲ / ▼ / ◀ / ▶ buttons
- 9 DISPLAY button
- 10 RED/GREEN/YELLOW/BLUE button  
SEARCH (BLUE) button (VCR)
- 11 REV ◀◀ button
- 12 PLAY ▶▶ button
- 13 SKIP ◀◀ button (HDD/DVD)
- 14 VCR button
- 15 PAUSE || button
- 16 TIME SLIP button (HDD)
- 17 DUBBING button
- 18 SUBTITLE button
- 19 AD (Audio Description) button
- 20 HDMI button
- 21 I/⏻ ON/STANDBY button
- 22 PROG. ▲ / ▼ buttons
- 23 TIMER PROG. button
- 24 INFO ⓘ button
- 25 CLEAR button
- 26 GUIDE button
- 27 VARIABLE SKIP button (HDD/DVD)
- 28 DISC MENU button (HDD/DVD)
- 29 ENTER/OK button
- 30 RETURN/BACK button
- 31 FWD ▶▶ button
- 32 STOP ■ button
- 33 SKIP ▶▶ button (HDD/DVD)
- 34 HDD button
- 35 DVD button
- 36 REC ● button
- 37 REC MODE button
- 38 SAT.LINK button (HDD)
- 39 AUDIO 🔊 button

**Button names described in the Owner's Manual**  
The instructions in this manual are described mainly with the operations using the remote control. Some operations can be carried out using the buttons on the front panel.

### Note

- If you turn off this unit, [OPEN/CLOSE ▲] on the remote control is not available. Be sure to use [▲ OPEN/CLOSE] or [STOP/EJECT ■ / ▲] on the unit.

Introduction

Connections

Basic Setup /  
TV View Operation

Recording

Playback

Editing

Function Setup

VCR Functions

Others

## Installing Batteries in the Remote Control

Install 2 R6 (1.5 V) batteries (supplied) into the remote control, carefully match with the polarity indicated inside the battery compartment.

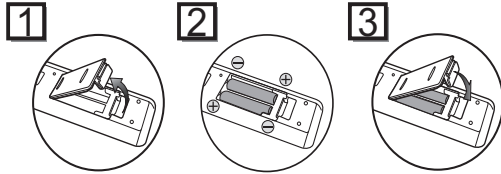

### Caution

- Incorrect use of batteries can result in hazards such as leakage and bursting.
- Do not mix new and old batteries together.
- Do not use different kinds of batteries together.
- Make sure that the plus (+) and minus (-) ends of each battery match the indications inside the battery compartment.
- Remove batteries if the equipment will not be used for a month or more.
- When disposing used batteries, please comply with governmental regulations or the public instructions for environmental protection that apply in your country or area.
- Do not recharge, short-circuit, heat, burn or disassemble batteries.

## About the Remote Control

- Make sure there is no obstacle between the remote control and the remote control sensor on the unit.
- Use within the operating range and angle as shown.

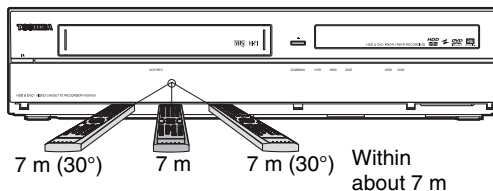

- The maximum operable range as follows:

**Line of sight:** approximately 7 m

**Either side of centre:** approximately 7 m within 30 degrees

- Remote control operation may become unreliable if the remote control sensor of the unit is being exposed by the strong sunlight or fluorescent light.
- Remote controls for different devices can interfere with each other. Be careful when using remote controls for other equipment located close to the unit.
- Replace the batteries when the operating range of the remote control reduces.

## Switching HDD / DVD / VCR mode

You must select which component you want to operate first. Press **[HDD]**, **[DVD]** or **[VCR]** on the remote control or the front panel.

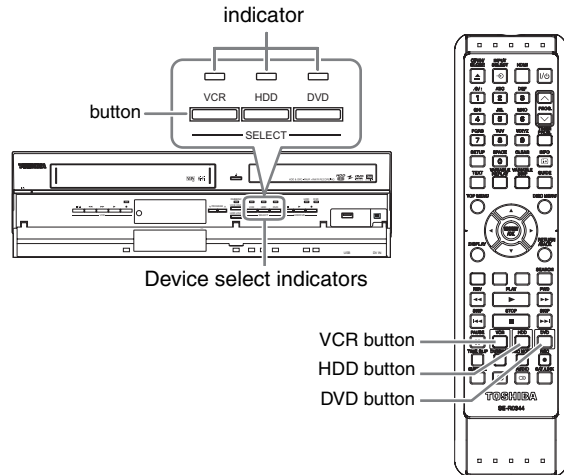

### HDD

Press **[HDD]** on the remote control or the front panel. (Verify that the HDD indicator is lit in blue.)

### DVD

Press **[DVD]** on the remote control or the front panel. (Verify that the DVD indicator is lit in green.)

### VCR

Press **[VCR]** on the remote control or the front panel. (Verify that the VCR indicator is lit in orange.)

## Guide to On-Screen Displays

### DISPLAY Menu

HDD

DVD

With a disc inserted into the unit, press **[DISPLAY]** to display the on-screen display. The on-screen display shows information about what is recorded on the disc.

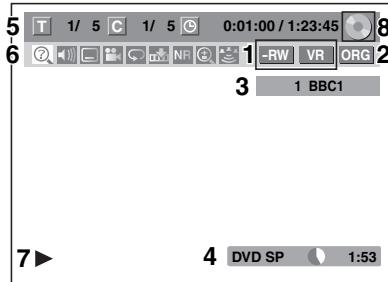

This is an example screen for explanation. Displayed items vary depending on the actual mode.

- 1 **Indicates a disc type and format mode. (DVD mode only)**
- 2 **Indicates a type of titles for HDD and VR mode DVD-RW disc.**
- 3 **Indicates a channel number, station name (analogue channel only) or selected external input mode.**
- 4 **Indicates a media, recording mode and possible recording time left.**
- 5 **Indicates the current title number/total number of titles, the current chapter number/total number of chapters, and time lapse of the current title playback/total duration of the title.**
- 6 **Each icon means:**
  - : Search
  - : Audio
  - : Subtitle
  - : Angle
  - : Repeat
  - : Marker
  - : Noise Reduction
  - : Zoom
  - : Surround
- 7 **Indicates an operation status.**
- 8 **Indicates the component in use.**
  - : HDD
  - : DVD
  - : USB device

#### Note

- For some descriptions on this manual, only one disc type is indicated as an example.

Press **[DISPLAY]** repeatedly while the display menu is displayed to display the following information.

#### <Title / File Name Information>

Title name information

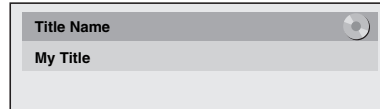

(only when DVD+RW/+R, VR mode DVD-RW, unfinalised video mode DVD-RW/-R disc or HDD is in playback)

File name information

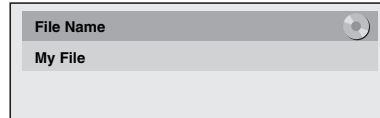

(only when MP3/JPEG/DivX® files is in playback)

#### <MP3 Tag Information>

(only when MP3 file is in playback)

Title name information

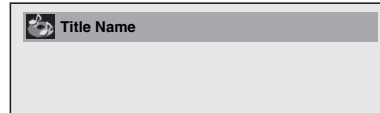

Artist name information

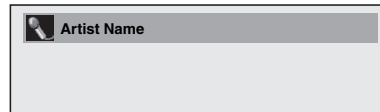

Album name information

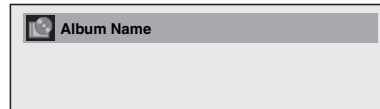

#### <HDMI Information>

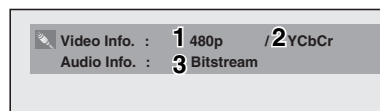

(only for the images output through the HDMI output)

- 1 **Indicates the resolution of the HDMI output image.**
- 2 **Indicates the HDMI video format.**
- 3 **Indicates the HDMI audio format.**
  - “- -” will be displayed, when it does not have any information.

Introduction

Connections

Basic Setup /  
TV View Operation

Recording

Playback

Editing

Function Setup

VCR Functions

Others

### VCR

While in the VCR mode, the on screen display of the VCR mode is displayed.

Press **[VCR]** first.

Press **[DISPLAY]** to display the on screen display.

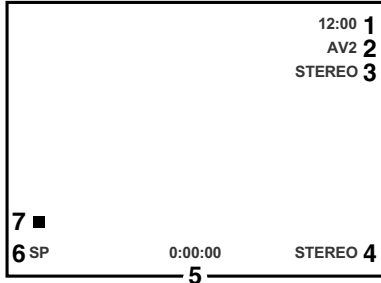

This is an example screen for explanation. Displayed items are depending on the actual mode.

- 1 **Current time**
- 2 **Position number**
- 3 **Audio status of the receiving broadcast or external equipment**
- 4 **Audio status of the currently playing back videotape**
- 5 **Tape counter**
- 6 **Recording or playing back speed**
- 7 **Status of the current tape**

### INFO Menu

#### DVB

Press **[INFO (i+)]** while viewing a DVB programme to display the programme information.

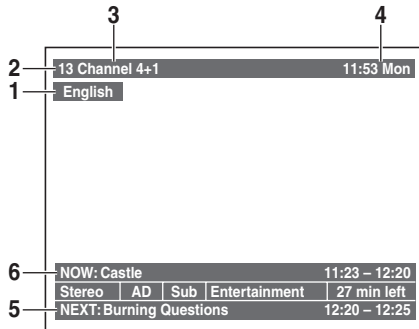

- 1 **Audio language**
- 2 **Channel number**
- 3 **Channel name**
- 4 **Current time and day**
- 5 **Next programme information**
- 6 **Current programme information**

The window will automatically exit after 4 seconds, or press **[RETURN/BACK]** to exit.

While the window appears, press **[INFO (i+)]** again to display more information. Press **[RETURN/BACK]** to exit.

### Main Menu

Press **[SETUP]** to display the main menu. Then use **[▲ / ▼]** to select a menu and press **[ENTER/OK]** to display the sub menu.

Press **[RETURN/BACK]** to return to previous screen.

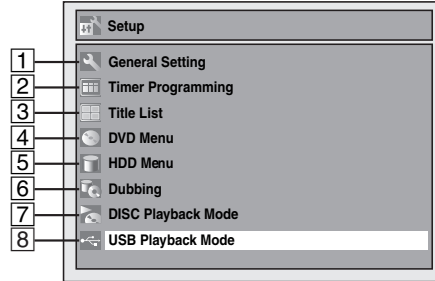

- 7 is displayed when a disc with CD-DA/VCD/MP3/JPEG is inserted.
- 8 is displayed when a USB flash memory with MP3/JPEG is plugged.

### 1 General Setting

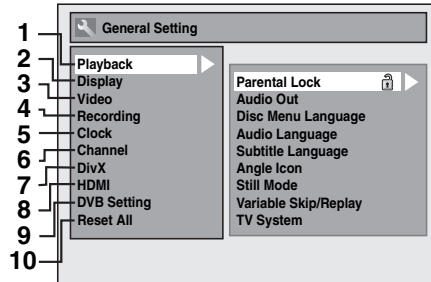

- 1 **Playback:** [➡ Page 68]
- 2 **Display:** [➡ Page 70]
- 3 **Video:** [➡ Page 71]
- 4 **Recording:** [➡ Pages 30-32, 38, 45]
- 5 **Clock:** [➡ Page 71]
- 6 **Channel:** [➡ Pages 20-26]
- 7 **DivX:** [➡ Pages 49, 72]
- 8 **HDMI:** [➡ Page 72]
- 9 **DVB Setting:** [➡ Page 73]
- 10 **Reset All:** [➡ Page 73]

### DVB Setting

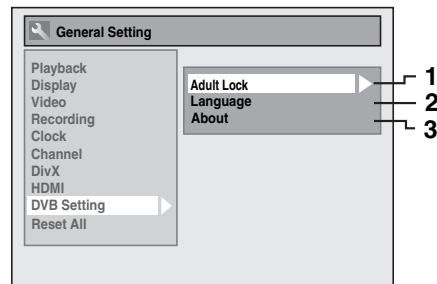

- 1 **Adult Lock:** [➡ Page 73]
- 2 **Language:** [➡ Page 73]
- 3 **About:** [➡ Page 73]

## 2 Timer Programming

To programme a timer recording. [➔ Page 33]

## 3 Title List

To call up the title list. [➔ Page 58]

## 4 DVD Menu

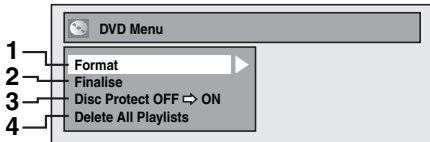

- 1 **Format (DVD-RW, DVD+RW only):** [➔ Pages 30, 31]
- 2 **Finalise:** [➔ Page 45]
- 3 **Disc Protect (VR mode DVD-RW, DVD+RW/+R disc only):** [➔ Page 44]
- 4 **Delete All Playlists (VR mode DVD-RW disc only):** [➔ Page 63]

## 5 HDD Menu

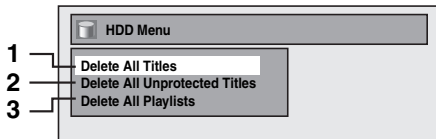

- 1 **Delete All Titles:** [➔ Page 64]
- 2 **Delete All Unprotected Titles:** [➔ Page 64]
- 3 **Delete All Playlists:** [➔ Page 63]

## 6 Dubbing

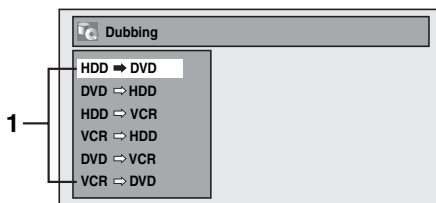

- 1 **Dubbing menu:** [➔ Page 43]

## 7 DISC Playback Mode

Audio CD / video CD

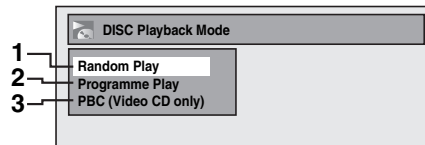

- 1 **Random Play:** [➔ Page 55]
- 2 **Programme Play:** [➔ Page 56]
- 3 **PBC (Video CD only):** [➔ Page 51]

CD-RW/-R with MP3 / JPEG files

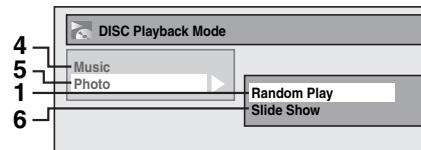

- 4 **Music (MP3 files):** [➔ Page 55]
- 5 **Photo (JPEG files):** [➔ Pages 55, 56]
- 6 **Slide Show:** [➔ Page 56]

## 8 USB Playback Mode

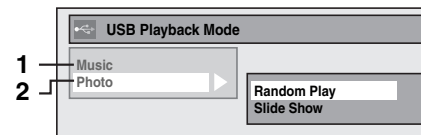

- 1 **Music (MP3 files):** [➔ Page 55]
- 2 **Photo (JPEG files):** [➔ Pages 55, 56]

Introduction

Connections

Basic Setup /  
TV View Operation

Recording

Playback

Editing

Function Setup

VCR Functions

Others

## Front Panel Display Guide

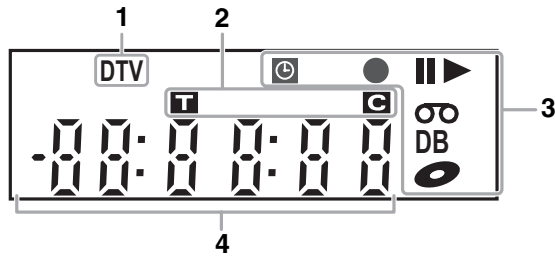

### 1 DTV indicator

**DTV**: Appears when the channel is in digital mode.

### 2 Title / Track and Chapter number

**T**: Title / track number

**C**: Chapter number

### 3 Current status of the unit

- II**: Appears when playback is paused.  
Appears during step by step playback.
- ▶**: Appears when playing back an HDD or disc.
- II▶**: Appears during slow forward / reverse playback.
- ⏻**: Appears when the timer programming or One-touch Timer Recording (OTR) is set and operating. Appears when the unit goes into the satellite link standby or recording mode. Flashes when timer programming and satellite recording was not executed because of some error.
- : Appears during recording. Flashes when recording being paused.

**⊞**: Appears when a videotape is in this unit.

**Ⓛ**: Appears when a disc is in this unit.

**DB**: Appears during dubbing.

### 4 Displays the following

- Playing back time
- Current title / chapter / track / file number
- Recording time / remaining time
- Clock
- Channel number
- One-touch Timer Recording (OTR) remaining time
- Selected HDMI video resolution

#### Note

- Except when satellite recording is in standby, front panel display stays off while the power is off.  
**This is a new Power Save (ECO) feature.**

## Display Messages



The disc tray is opening.

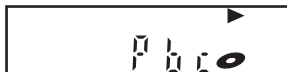

The PBC function of the video CD is activated.



The disc tray is closing.



A disc is loading.

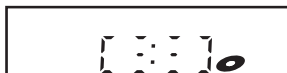

Data is being recorded on a disc.

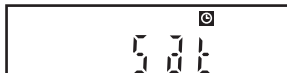

Appears when the satellite link recording is in standby.



Appears when HDMI video resolution (480p) is selected.



Appears when HDMI video resolution (576p) is selected.



Appears when HDMI video resolution (720p) is selected.



Appears when HDMI video resolution (1080i) is selected.



Appears when HDMI video resolution (1080p) is selected.



# Connections

## Connecting to a TV

Connect the unit to a TV after considering the capabilities of your existing equipment.

**Before installation, unplug your TV and this unit.**

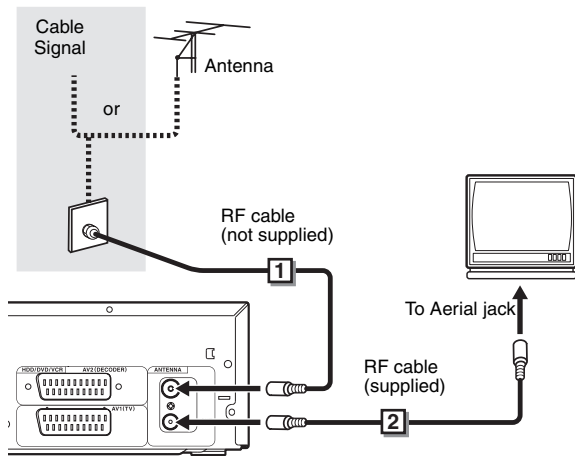

- 1** Connect the antenna or cable to the **ANTENNA IN** jack of this unit.
- 2** Connect the **ANTENNA OUT** jack of this unit to the **Aerial** jack of your TV.

## Using the Scart socket

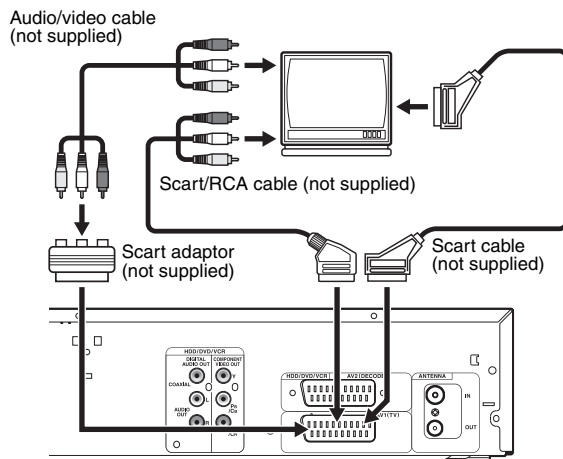

**Connect AV1 (TV) Scart socket of this unit to the Scart socket of your TV.**

### Note

- If your TV does not have a Scart socket, use a Scart/RCA cable to connect.
- Connect this unit directly to the TV. If the AV cables are connected to a VCR, pictures may be distorted due to the copy protection system.

- Analogue teletext can only be output in VCR mode through AV1 (TV) out. Use TV remote control to decode the analogue teletext.
- When changing the "Video Out" setting ("SCART (RGB)", "Component (Interlace)" or "Component (Progressive)"), connect to the corresponding jack on the TV. If the setting is changed, for example, to "Component (Interlace)" or "Component (Progressive)" while the scart cable is connected to the TV, a distorted video signal may be output.

## Using the COMPONENT VIDEO OUT Jacks and the AUDIO OUT (L/R) Jacks

If your TV has component video input jacks, use a component video cable and an audio cable (to connect the AUDIO OUT (L/R) jacks).

When using this type of connection, "Video Out" setting should be set to "Component (Progressive)" or "Component (Interlace)". Refer to "Video Out" on page 71.

- Component connection provides the better quality picture.

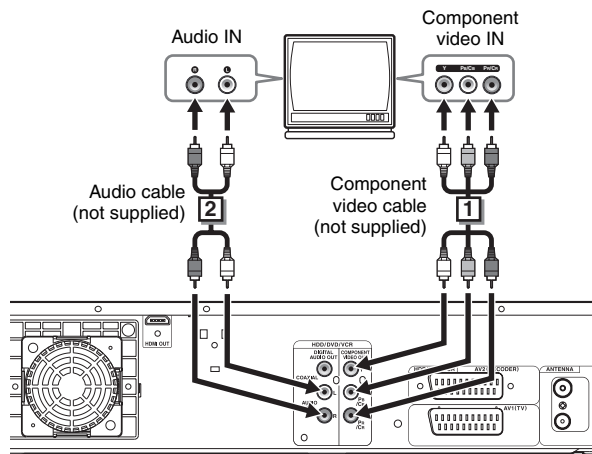

- 1** Connect the **COMPONENT VIDEO OUT** jacks of this unit to the **component video input jacks** of your TV.
- 2** Connect the **AUDIO OUT (L/R)** jacks of this unit to the **analogue audio input jacks** of your TV.

• After you have made the connections, set the "Video Out" setting. (See page 71.)

## Selecting Progressive Scan (576p/480p or Interlaced 576i/480i) Playback

- If your TV is compatible with progressive scanning (576p/480p), connect the TV to the COMPONENT VIDEO OUT jacks of this unit and set "Video Out" setting to "Component (Progressive)" in "Setup" menu. (See page 71.) Next, set your TV to the progressive scan mode.
- If your TV is not compatible with progressive scan, set "Video Out" setting to "Component (Interlace)".
- Use a commercially available adaptor if the video input jacks of your TVs or monitors are the BNC type.
- Only component and HDMI connections are compatible with the Progressive Scan.

Introduction

Connections

Basic Setup /  
TV View Operation

Recording

Playback

Editing

Function Setup

VCR Functions

Others

## Using an HDMI Compatible Port

### [HDMI CONNECTION]

- HDMI outputs the video / audio signals without converting to analogue signals.
- No audio connections is required.
- Use the HDMI cable (commercially available) for connection.
- Connect the HDMI output jack of this unit to the HDMI input jack of TV.

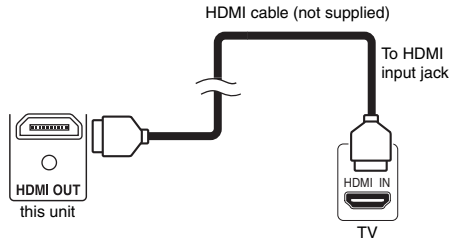

### Selecting HDMI video resolution

Press **[HDMI]** to select the HDMI video resolution. The video resolution changes as follows every time **[HDMI]** is pressed.  
576p (PAL) / 480p (NTSC) → 720p → 1080i → 1080p  
(An HDMI video resolution that is not supported by the display device will be skipped.)

## Actual Output Modes by Media

Audio recording format of the disc		Dolby Digital / DTS / MPEG setting of this unit	Actual output
DVD-video	Dolby Digital	PCM	2 channel PCM
		Stream	Dolby Digital
	LPCM	PCM	2 channel PCM
		Stream	
	DTS®	ON	DTS®
		OFF	-
	MPEG	PCM	2 channel PCM
		Stream	MPEG
DivX®	Dolby Digital	PCM	2 channel PCM
		Stream	Dolby Digital
	MP3	PCM	2 channel PCM
		Stream	
	MP2	PCM	2 channel PCM
		Stream	MPEG

For audio CD, video CD and MP3 files, 2 channel PCM will be output regardless of the “Dolby Digital” setting.

If the connected device is not compatible with HDMI BITSTREAM, audio will be output as PCM even if you select “Stream” in “Dolby Digital” setting. (See page 69.)

### Copyright protection system

To play back the digital video images of a DVD via an HDMI connection, it is necessary that both the player and the display device (or an AV amplifier) support a copyright protection system called HDCP (high-bandwidth digital content protection system). HDCP is copy protection technology that comprises data encryption and authentication of the connected AV device. This unit supports HDCP. Please read the operating instructions of your display device (or AV amplifier) for more information.

\* HDMI: High Definition Multimedia Interface

### Note

- Because HDMI is an evolving technology, it is possible that some devices with an HDMI input may not operate properly with this unit.
- When using an HDCP-incompatible display device, the image will not be viewed properly.
- Among the devices that support HDMI, some devices can control other devices via the HDMI connector; however, this unit cannot be controlled by another device via the HDMI connector.
- The audio signals from the HDMI connector (including the sampling frequency, the number of channels and bit length) may be limited by the device that is connected.
- Among the monitors that support HDMI, some do not support audio output (for example, projectors). In connections with device such as this unit, audio signals are not output from the HDMI output connector.
- When this unit's HDMI connector is connected to a DVI-D compatible monitor (HDCP compatible) with an HDMI-DVI conversion cable, the signals are output in digital RGB.
- If the connected equipment is not compatible with HDMI BITSTREAM, DTS sound will not be output.
- When the power failure occurs, or when you unplug the unit, some problems in the HDMI setting might occur. Please check and set the HDMI setting again.

## Connecting to External Equipment

This unit has three input terminals. Press **[INPUT SELECT ↻]** repeatedly to select the external input mode, then press **[PROG. ▲ / ▼]** repeatedly to select AV1, AV2 or DV(AV3). Be sure that all the units are switched off before making connections.

### Recording from a DVD player, Satellite Box or other Audio-Video equipment with a Scart output socket (AV2)

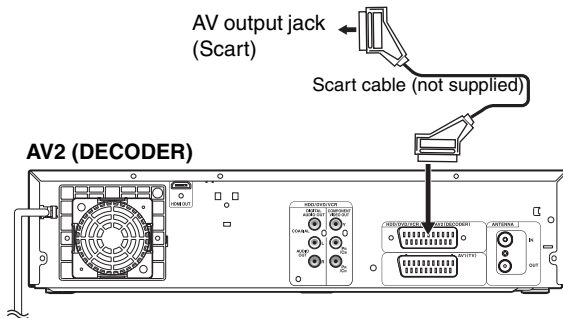

#### Note

- When you record a TV programme from a Satellite Box / decoder, you must connect a Scart cable to AV2 (DECODER). (See page 37.)
- The signal from the external device will be output automatically when the TV is connected to AV1 and the external device is connected to AV2 using a Scart cable with its power on. (However, it will not be output when this unit's power is turned off.)  
**If you want to monitor this unit's signal, press [DISPLAY] or turn the external device off. (The signal from this unit can only be monitored during playback.)**  
**If you want to monitor the signal from other input, press [DISPLAY], then press [INPUT SELECT ↻] to select the desired external input mode, then select the desired input channel using [PROG. ▲ / ▼].**

### Recording from a DV-camcorder (DV(AV3))

When connecting a DV-camcorder, use DV input jack of DV(AV3) (Front).

#### DV(AV3) (Front)

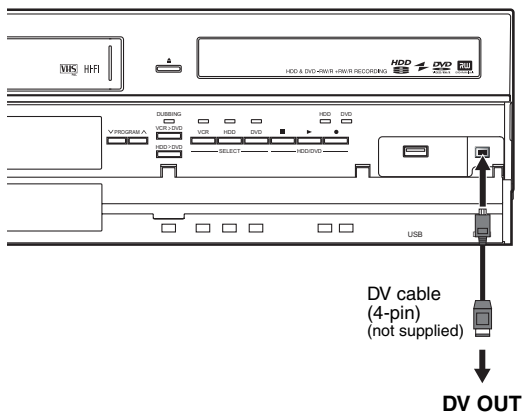

## Digital Audio for Better Sound Quality

Dolby Digital decoder, DTS decoder or MPEG decoder, etc.

Digital audio input jack

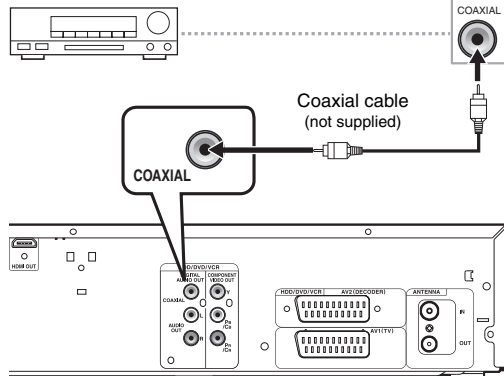

The connections illustrated above are optional for better sound.

For clear digital sound quality, use the **DIGITAL AUDIO OUT (COAXIAL) jack to connect your digital audio equipment.**

If the audio format of the digital output does not match the capabilities of your receiver, the receiver will produce a strong, distorted sound or no sound at all.

### Connecting a Dolby Digital™ decoder, DTS decoder or MPEG decoder

- Connecting multi-channel Dolby Digital decoder allows you to enjoy the Multi-channel Dolby Digital surround system as well as DTS decoder, Multi-channel surround system.
- After connecting to a Dolby Digital decoder, set "Dolby Digital" to "Stream" in "Audio Out" menu. (See page 69.)
- After connecting to a DTS decoder, set "DTS" to "ON" in "Audio Out" menu. (See page 69.)
- After connecting to a MPEG decoder, set "MPEG" to "Stream" in "Audio Out" menu. (See page 69.)

### Connecting to an MD deck or DAT deck

- The audio source recorded in Dolby Digital Multi-channel surround format cannot be recorded using an MD or DAT deck as a digital sound.
- If not connected to a Dolby Digital decoder, set "Dolby Digital" to "PCM" in "Audio Out" menu. Playing back a DVD using incorrect settings may generate noise distortion and damage speakers.
- Set "Dolby Digital" and "MPEG" to "PCM" and set "DTS" to "OFF" in "Audio Out" menu for connecting to an MD or DAT deck.
- You can use AUDIO OUT (L/R) jacks for the connection of your audio system.

Introduction

Connections

Basic Setup /  
TV View Operation

Recording

Playback

Editing

Function Setup

VCR Functions

Others

# Basic Setup / TV View Operation

## Initial Setting

When you turn on this unit for the first time, you need to follow these steps.

- 1 Press [I/⏻ ON/STANDBY].
- 2 Turn the TV on. Select the input to which the unit is connected.
- 3 Select your desired tuning type according to your area using [▲ / ▼], then press [ENTER/OK].

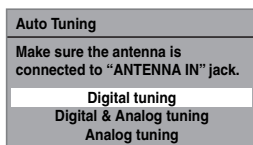

The unit will start getting channels available in your area.

### Digital tuning:

Only the DVB channels receivable in your area are automatically scanned and memorised.

### Digital & Analog tuning:

Both analogue and DVB channels receivable in your area are scanned and memorised automatically.

### Analog tuning:

Only the analogue channels receivable in your area are automatically scanned and memorised.

- If no channel has been memorised, the antenna confirmation display will appear. Press [ENTER/OK] to start auto scanning again or press [RETURN/BACK] to cancel the initial settings.

- 4 After finishing channel setting, "Clock Setting" will appear.

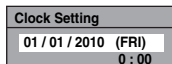

- The current date and time will appear automatically.
- If the current date and time are correct, press [RETURN/BACK] to exit, if they are incorrect, press [ENTER/OK] and follow to "[F1] Clock Setting" on page 71.

### Note

- After "Initial Setting", if you need to unplug the mains cable, make sure to turn off the power first and leave it in standby mode for at least 1 minute before attempting to unplug. Otherwise, it may cause data loss.

If you want to set each item of "Initial Setting" again, you can set them at "General Setting".

- Refer to "Auto Tuning (DVB & ANALOG)" on this page.
- Refer to "Auto Tuning (ANALOG)" on page 21.
- Refer to "Auto Tuning (DVB)" on page 22.
- Refer to "Clock" on page 71.

Also you can customize the memorised channel at "General Setting".

Refer to following pages for details.

- Refer to "Manual Tuning (ANALOG)" on page 21.
- Refer to "Manual Tuning (DVB)" on page 22.
- Refer to "Skip a Preset Channel" on page 22.
- Refer to "Move" on page 22.

## Selecting the TV Aspect Ratio

Use this feature to adjust the aspect ratio of the video source which is different from your TV's ratio to fit your TV monitor without distorting the picture.

- 1 In stop mode, press [SETUP]. Select "General Setting" using [▲ / ▼], then press [ENTER/OK].
- 2 Select "Video" using [▲ / ▼], then press [ENTER/OK].
- 3 Select "TV Aspect" using [▲ / ▼], then press [ENTER/OK].



- 4 Select the desired option using [▲ / ▼], then press [ENTER/OK].

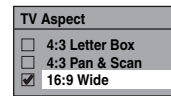

- 5 Press [SETUP] to exit.

### Note

If you have a standard TV:

- Select "4:3 Letter Box" for a full width picture with black bars at the top and bottom.
- Select "4:3 Pan & Scan" for a full height picture with both sides trimmed.

If you have a wide screen TV:

- Select "16:9 Wide".

## Channel Setting

You can retune this unit or edit the channel setting with following methods.

### Auto Tuning (DVB & ANALOG)

DVB

ANALOG

Programme the tuner to scan both analogue and DVB channels you can receive in your area.

- 1 In stop mode, press [SETUP]. Select "General Setting" using [▲ / ▼], then press [ENTER/OK]. "General Setting" menu will appear.
- 2 Select "Channel" using [▲ / ▼], then press [ENTER/OK].

**3 Select “Auto Tuning (DVB & ANALOG)” using [▲ / ▼], then press [ENTER/OK].**

The unit will start storing channels available in your area.

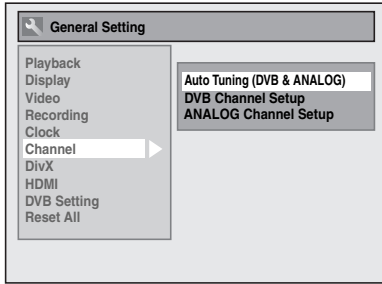

Wait for several minutes to finish channel storing.

**4 Press [SETUP] to exit.**

You can select only the channels memorised in this unit by using [PROG. ^ / v].

**To cancel auto tuning**

Press [SETUP] during scanning.

**Note**

- The number of TV channels you can get is different depends on your local area.
- If the auto tuning is cancelled during scanning, some channels not yet tuned may not be received.

**Auto Tuning (ANALOG)**

**ANALOG**

Programme the tuner to scan only the analogue channels you can receive in your area.

**1 In stop mode, press [SETUP]. Select “General Setting” using [▲ / ▼], then press [ENTER/OK].**

**2 Select “Channel” using [▲ / ▼], then press [ENTER/OK].**

**3 Select “ANALOG Channel Setup” using [▲ / ▼], then press [ENTER/OK].**

**4 Select “Auto Tuning” using [▲ / ▼], then press [ENTER/OK].**

The unit will start storing channels available in your area.

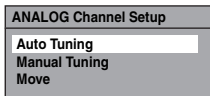

Wait for several minutes to finish channel storing.

**5 Press [SETUP] to exit.**

You can select only the channels memorised in this unit by using [PROG. ^ / v].

**To cancel auto tuning**

Press [SETUP] during scanning.

**Note**

- The number of TV channels you can get is different depends on your local area.
- If the auto tuning is cancelled during scanning, some channels not yet tuned may not be received.
- Sorting of TV channels from 1 to 6 will be performed automatically as follows.
 

1: BBC1	2: BBC2	3: ITV
4: CH4	5: CH5	6: SKY NEWS

- If you are using a satellite receiver, or a cable box, turn it on and select SKY NEWS before commencing tuning. If the SKY NEWS channel is not available to you, choose another channel that you can recognise easily, and move this reception to preset 6 after the automatic tuning has finished. Instructions on page 22 explain how to move channels.

**Manual Tuning (ANALOG)**

**ANALOG**

You can preset an analogue channel manually and individually.

**1 In stop mode, press [SETUP]. Select “General Setting” using [▲ / ▼], then press [ENTER/OK].**

**2 Select “Channel” using [▲ / ▼], then press [ENTER/OK].**

**3 Select “ANALOG Channel Setup” using [▲ / ▼], then press [ENTER/OK].**

**4 Select “Manual Tuning” using [▲ / ▼], then press [ENTER/OK].**

**5 Select “Position” using [▲ / ▼], then press [▶].**

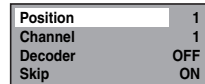

**6 Select the position number you want to use using [the Number buttons] or [▲ / ▼], then press [◀].**

- You can select position number 1-99.
- With [the Number buttons], press “0” first to enter a single digit number.

**7 Select “Channel” using [▲ / ▼], then press [▶].**

**8 Press [▲ / ▼] to start scanning.**

- The tuner will begin to search up or down automatically. When a channel is found, the unit will stop searching and the picture will appear on the TV screen.
- You can select a desired channel number using [the Number buttons]. Refer to the following Channel Plan table and press the three digits to select the channel number. (To select channel 4, press [0] first and then press [0] and [4]. Or press [4] and then “- - 4” appears and wait for 2 seconds.)
- If desired channel is found, press [◀].

Channel Plan	
CH Indication	TV Channel
1 – 10	IRA - IRJ, GAP
21 – 69	E21 – E69
74 – 78	X, Y, Z, Z+1, Z+2
80 – 99, 100	S1 – S20, GAP
121 – 141	S21 – S41

This unit can receive the Hyper and Oscar frequency bands.

- If you want to decode scrambled signals, select “Decoder” using [▲ / ▼], then press [▶]. Select “ON” using [▲ / ▼], then press [◀].
- If “Skip” is set to “ON”, select “Skip” using [▲ / ▼], then press [▶]. Select “OFF” using [▲ / ▼], then press [◀].
- To store another channel, repeat steps 5 to 8.

**9 Press [SETUP] to exit.**

## Skip a Preset Channel

### ANALOG

You can set the unit to skip channels. You can no longer receive or watch when you access channels using [PROG. ^ / v].

- Follow steps 1 to 4 in “Manual Tuning (ANALOG)” on page 21.
- Select “Position” using [▲ / ▼], then press [▶].
- Select the position number using [the Number buttons] or [▲ / ▼], then press [◀].
- Select “Skip” using [▲ / ▼], then press [▶].
- Select “ON” using [▲ / ▼], then press [◀].
  - To skip another channel, repeat steps 2 to 5.
- Press [SETUP] to exit.

## Move

### ANALOG

You can replace two channels.

- In stop mode, press [SETUP]. Select “General Setting” using [▲ / ▼], then press [ENTER/OK].
- Select “Channel” using [▲ / ▼], then press [ENTER/OK].
- Select “ANALOG Channel Setup” using [▲ / ▼], then press [ENTER/OK].
- Select “Move” using [▲ / ▼], then press [ENTER/OK].
- Select the position number to change the channel using [▲ / ▼], then press [ENTER/OK].
 

You cannot select a position number where “\_ \_ \_” appears next to the number, because “Skip” is set to “ON” for that position number.
- Move the channel to another position number using [▲ / ▼], then press [ENTER/OK].
  - To move another channel, repeat steps 5 to 6.
- Press [SETUP] to exit.

## Auto Tuning (DVB)

### DVB

You can programme the tuner to scan only the DVB channels that you can receive in your area.

- In stop mode, press [SETUP]. Select “General Setting” using [▲ / ▼], then press [ENTER/OK].
- Select “Channel” using [▲ / ▼], then press [ENTER/OK].
- Select “DVB Channel Setup” using [▲ / ▼], then press [ENTER/OK].
- Select “Auto Tuning” using [▲ / ▼], then press [ENTER/OK].

The unit will start storing channels available in your area.

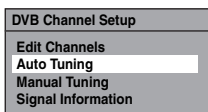

The tuner scans and memorises all the active DVB channels (TV / Radio) in your area.

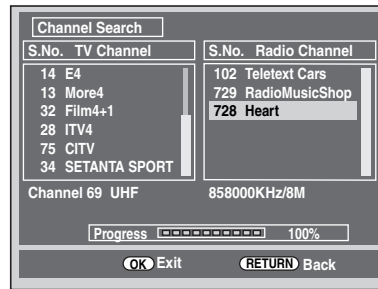

- Press [ENTER/OK] to exit.

- After auto tuning is completed, the lowest memorised DVB channels appears on the screen.
- You can use [PROG. ^ / v] to change the DVB channels.

### Note

- If you press [RETURN/BACK] or [SETUP] during the scanning, auto tuning will be cancelled.

## Manual Tuning (DVB)

### DVB

You can preset a DVB channel manually and individually.

- Follow steps 1 to 3 in “Auto Tuning (DVB)” on this page.
- Select “Manual Tuning” using [▲ / ▼], then press [ENTER/OK].
- Select your desired position number using [▲ / ▼], then press [ENTER/OK].



- The tuner will begin to search up or down automatically. When a DVB channel is found, the unit will stop searching.
  - When “Auto” is selected, the unit will search for the channels which have not been stored in channels memory.
- Press [SETUP] to activate the setting.

## Service Update

### DVB

This unit has “Service Update” function which searches and stores newly available digital channels automatically at 8:00. If a new channel is found, a message will appear on the screen when you turn on the DVB channel at first time after storing a new channel. Press any button to clear the message.

## TV View Operation

The following operations are available while viewing TV channels through this unit's tuner.

### Select a Channel

**DVB**

**ANALOG**

To switch DVB, analogue and external input (AV1/AV2/DV(AV3)) mode.

Press **[INPUT SELECT ↵]** repeatedly to select DVB, analogue or external input mode.

The mode changes as follows:

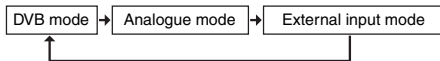

You can select external input mode (AV1/AV2/DV(AV3)) by pressing **[PROG. ▲ / ▼]** repeatedly.

The mode changes as follows:

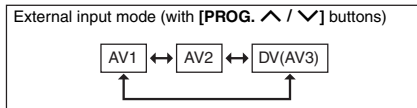

You can select a channel using **[PROG. ▲ / ▼]** or directly enter the channel using **[the Number buttons]**.

#### Notes on using [the Number buttons]:

- For one or two-digit number channels, the channels will be identified for 2 seconds after you press the channel number. You can only select channels 1~899 (Digital) or 1~99 (Analogue).
- If you cannot get a "Station Name" of Analogue channel, it is not indicated with a channel number.

### Selecting the Audio Mode

**ANALOG**

You can switch between TV audio modes by pressing **[AUDIO ⏮]**. Each mode is indicated on the TV screen.

#### Audio mode during reception of analogue bilingual broadcasts:

Mode	Audio output	Display on the TV screen
Main	Main audio from both speakers	Main
Sub	Sub audio from both speakers	Sub
Main / Sub	<ul style="list-style-type: none"> <li>Main audio from the left speaker</li> <li>Sub audio from the right speaker</li> </ul>	Main/Sub

- If the programme does not have more than one sound track, **[AUDIO ⏮]** is not effective.

## Quick Select

**DVB**

With "Quick Select" menu, you can select your favourite DVB channel quickly. Refer to "Edit Group Lists" on page 24.

### 1 Press [ENTER/OK] while watching a DVB channel.

- "Quick Select" menu will appear.

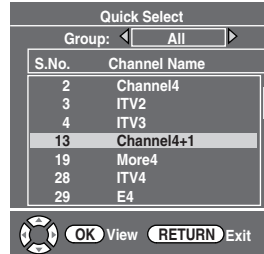

### 2 Press [◀ / ▶] to select your favourite group list. ("All", "Group 1" - "Group 8")

- "All" shows a list of all the memorised DVB channels.
- If the favourite group does not have any channels, the group will be skipped.

### 3 Select the DVB channel using [▲ / ▼], then press [ENTER/OK].

### 4 Press [RETURN/BACK] to exit.

Introduction

Connections

Basic Setup /  
TV View Operation

Recording

Playback

Editing

Function Setup

VCR Functions

Others

## Edit Channels

### DVB

With "Edit Channels" menu, you can sort all the memorised DVB channels into the group lists ("Quick Select") or set the viewer limitation ("Adult Lock"), etc.

- 1 In stop mode, press [SETUP]. Select "General Setting" using [ $\blacktriangle$  /  $\blacktriangledown$ ], then press [ENTER/OK].
- 2 Select "Channel" using [ $\blacktriangle$  /  $\blacktriangledown$ ], then press [ENTER/OK].
- 3 Select "DVB Channel Setup" using [ $\blacktriangle$  /  $\blacktriangledown$ ], then press [ENTER/OK].
- 4 Select "Edit Channels" using [ $\blacktriangle$  /  $\blacktriangledown$ ], then press [ENTER/OK].

- "Edit Channels" menu will appear.

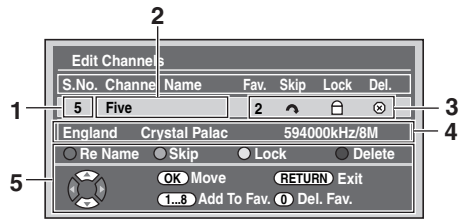

- 1 Channel number
  - 2 Channel name
  - 3 Channel setting
    - 1 to 8: The number of the favourite group list
    - $\blacktriangle$ : Skip Channels
    - $\square$ : Adult Lock
    - $\otimes$ : Delete Channels
  - 4 Channel information
  - 5 Operation Guide
- 5 Press [RETURN/BACK] to exit.

## Edit Group Lists

### DVB

You can sort each DVB channel into 8 different favourite group lists ("Group 1" - "Group 8"). With "Quick Select" menu, you can select your favourite DVB channel quickly. Refer to "Quick Select" on page 23.

- 1 Follow steps 1 to 4 in "Edit Channels" on this page.
- 2 Select the DVB channel you want to add to the favourite group list using [ $\blacktriangle$  /  $\blacktriangledown$ ], then select the number of the favourite group list you want to add using [the Number buttons] ([1] - [8]).



- The number you selected will appear.
- Press [0] to cancel from the favourite group list.

- 3 Press [RETURN/BACK] to exit.

## Skip Channels

### DVB

You can set the unit to skip the unwanted DVB channels when you use [PROG.  $\blacktriangle$  /  $\blacktriangledown$ ].

- 1 Follow steps 1 to 4 in "Edit Channels" on this page.
- 2 Select the DVB channel you want to skip using [ $\blacktriangle$  /  $\blacktriangledown$ ], then press [GREEN].

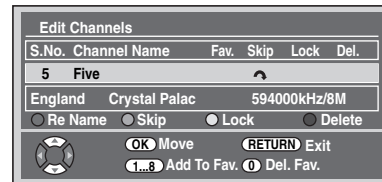

- " $\blacktriangle$ " will appear.
- Press [GREEN] to cancel. " $\blacktriangle$ " will disappear.

- 3 Press [RETURN/BACK] to exit.





## Adult Lock

### DVB

You can set the unit to limit the access to the DVB channels.

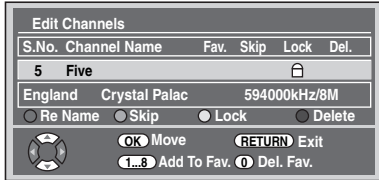
- Follow steps 1 to 4 in “Edit Channels” on page 24.
- Select the DVB channel you want to limit the access using [▲ / ▼], then press [YELLOW].



- “” will appear.
- Press [YELLOW] to cancel. “” will disappear.

- Press [RETURN/BACK] to exit.

- Once you turn off the unit, Pincode will be required to view the locked channels.
- To set the Pincode, refer to “ Adult Lock (Default: OFF)” on page 73.

### Note

- You need to set the Pincode first to activate the “Adult Lock” in “DVB Setting”. After you set a Pincode, you have to turn off the power and then turn it on again to activate the setting.



## Delete Channels

### DVB

You can delete the DVB channels from the memorised DVB channels.

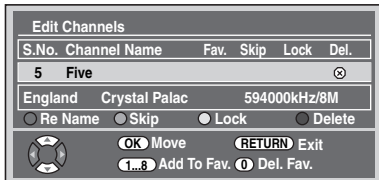
- Follow steps 1 to 4 in “Edit Channels” on page 24.
- Select the DVB channel you want to delete using [▲ / ▼], then press [BLUE].



- “” will appear.
- Press [BLUE] to cancel. “” will disappear.

- Press [RETURN/BACK] to exit.

- The channel has been deleted from the “Edit Channels” menu.

## Channel Move

### DVB

You can change the order of the DVB channels when you use [PROG. ▲ / ▼].

- Follow steps 1 to 4 in “Edit Channels” on page 24.
- Select the DVB channel you want to change the position using [▲ / ▼], then press [ENTER/OK]. Pop up window will appear.
- Select the channel you want to replace with using [▲ / ▼], then press [ENTER/OK].

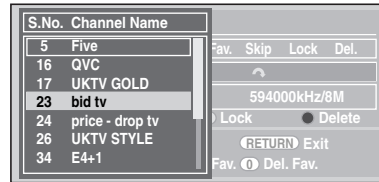

- The channel will be replaced.

- Press [RETURN/BACK] to exit.

## Edit Channel Names

### DVB

You can edit the DVB channel names as you want.

- Follow steps 1 to 4 in “Edit Channels” on page 24.
- Select the DVB channel you want to edit the name using [▲ / ▼], then press [RED].
  - Name editing display will appear.

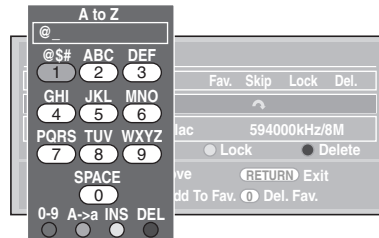

- Edit the name using [the Number buttons].

- Press [the Number buttons] repeatedly until the desired letter appears.
- Press [◀ / ▶] to move the cursor left or right.
- Press [RED] to select alphabet or numbers.
- Press [GREEN] to select capital or small letters.
- Press [YELLOW] to move the letter on the cursor to the right.
- Press [BLUE] to delete the letter on the cursor, and move the cursor to the left.

- After completion, press [ENTER/OK].

- Press [RETURN/BACK] to exit.

### Note

- You can enter up to 19 letters.

Introduction

Connections

Basic Setup /  
TV View Operation

Recording

Playback

Editing

Function Setup

VCR Functions

Others

## Signal Information

### DVB

You can check the detailed information of the current DVB channel.

- 1 Follow steps 1 to 3 in “Auto Tuning (DVB)” on page 22.
- 2 Select “Signal Information” using [ $\blacktriangle$  /  $\blacktriangledown$ ], then press [ENTER/OK].
  - “Signal Information” display will appear.

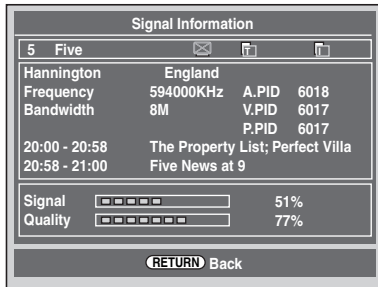

- 3 Press [RETURN/BACK] to exit.
  - “Signal Information” is not available for analogue channel and external input (AV1/AV2/DV(AV3)).
  - “Signal Information” is also not available while the Pincode input field for locked DVB channel is displayed.

## Digital Teletext Reception

### DVB

Many broadcasters provide a DVB Teletext service in the form of a dedicated Teletext channel. This Digital service includes high quality text and graphics along with advanced navigation options.

- 1 Press [TEXT] to display Teletext screen.
  - Teletext for the TV channel will be displayed.
- 2 Use [RED] / [GREEN] / [YELLOW] / [BLUE] to follow the instructions on screen.
- 3 Press [TEXT] to switch the Teletext display off.

#### Note

- This unit supports MHEG5 data service.
- This unit does not support MHP data service.
- If you display the Teletext screen during the recording, the Teletext screen will be recorded. In addition, you cannot use [the Number buttons] for changing Teletext pages. Use [ $\blacktriangle$  /  $\blacktriangledown$  /  $\blacktriangleleft$  /  $\blacktriangleright$ ] and [ENTER/OK] to change the Teletext pages.
- When “Subtitle” is set to “ON”, Teletext will not be displayed.

## Multi Audio

### DVB

Many DVB channels transmit Multi Audio information along with their DVB channels. You can select the desired audio mode and audio language.

- 1 While viewing a DVB programme, press [AUDIO  $\infty$ ].



- 2 Select “Stereo”, “Left” or “Right” using [ $\blacktriangleleft$  /  $\blacktriangleright$ ].
- 3 Select your desired audio language using [ $\blacktriangle$  /  $\blacktriangledown$ ].
  - The available audio language varies depending on the DVB programmes.
- 4 Press [ENTER/OK] to activate the settings.

#### Note

- If the programme is changed, the audio language will be switched back to the default language you set in the “DVB Setting”. Refer to “[2] Language” on page 73.

## Subtitle

### DVB

Many DVB channels transmit Subtitle information along with their DVB channels. You can retrieve and display it on the TV screen.

- 1 While viewing a DVB programme, press [SUBTITLE].
  - If the programme has no subtitle information, “No Information.” will appear.

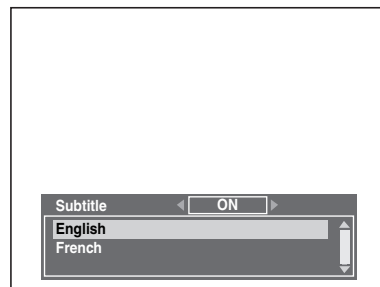

- 2 Select “ON” or “OFF” using [ $\blacktriangleleft$  /  $\blacktriangleright$ ].
- 3 Select your desired subtitle language using [ $\blacktriangle$  /  $\blacktriangledown$ ].
  - The available subtitle language varies depending on the DVB programmes.
- 4 Press [ENTER/OK] to activate the settings.

**Note**

- If the programme is changed, the subtitle language will be switched back to the default language you set in the “DVB Setting”. Refer to “[2] Language” on page 73. If the default subtitle language is not available on the new programme, no subtitle will be displayed.

**Audio Description**

**DVB**

You can receive “Audio Description” service via DVB channels and listen to it as a sub-audio. It is possible to adjust the AD level separately from the volume of the TV programme using [AD] button.

- 1 While viewing a DVB programme, press [AD].

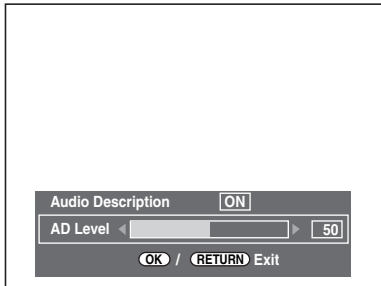

- 2 Select “ON” or “OFF” using [AD].
- 3 Select your desired AD Level using [◀ / ▶].
  - The AD Level can be set to 0 through 100. (Default: 80)
- 4 Press [ENTER/OK] to activate the settings.

**Note**

- Even if you exit from “Audio Description” or the unit is turned into Power OFF / STANDBY mode after you changed the AD Level, this unit keeps the setting.

**EPG (Electronic Programme Guide)**

**DVB**

Electronic programme guide (EPG) gives you a list of the DVB programmes and detailed information about the programmes. To call up EPG while viewing DVB/analogue channel or external input (AV1/AV2/DV(AV3)), press [GUIDE]. You can also call up EPG by following steps.

- 1 In stop mode, press [SETUP]. Select “Timer Programming” using [▲ / ▼], then press [ENTER/OK].
- 2 Select “EPG” using [▲ / ▼], then press [ENTER/OK].
  - Select the channel and TV programme using [▲ / ▼ / ▶ / ◀].
  - Press [ENTER/OK] or [BLUE] to go to “Timer Programming” menu after you select the TV programme using [▲ / ▼ / ▶ / ◀]. Refer to “Timer Recording (EPG)” on page 36.

e.g.) Weekly Mode

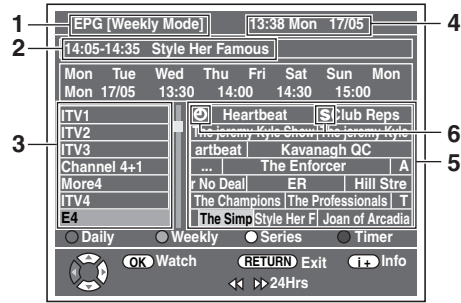

- 1 EPG menu mode
- 2 Programme you select now
- 3 Channel name
- 4 Time / Date
- 5 Programme name
- 6 Programmes set for the timer recording
  - Programmes set for the series link timer recording
  - Once only timer recording

- Press [RETURN/BACK] to exit.
- Press [RED] to display “Daily Mode”.
- Press [GREEN] to display “Weekly Mode”.
- Press [YELLOW] to see all series episodes linked to the selected programme.
- For the series link timer recording, refer to “Series Link Timer Recording” on page 37.
- Press [◀◀ / ▶▶] to move to the previous or the next day.
- Press [INFO] to display “Service Information”.

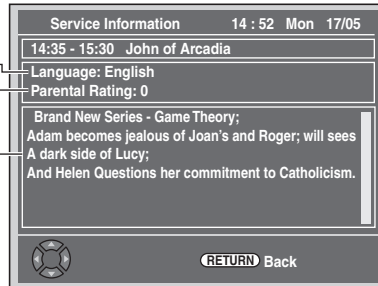

- 1 Language displayed on the screen
- 2 Parental Rating
- 3 Information about the programme

**Note**

- EPG cannot be displayed during recording.

Introduction

Connections

Basic Setup /  
TV View Operation

Recording

Playback

Editing

Function Setup

VCR Functions

Others

# Recording

## Information on DVD Recording

### Type of Discs

This unit can record on DVD-RW/+R discs and DVD+RW/+R discs.

DVD-R/+R discs allow you to record programmes only once, and the recorded contents can be erased although the space left on the disc does not change.

DVD-RW/+RW discs allow you to record programmes repeatedly, and the recorded contents can be erased.

There are 3 recording formats: VR mode, video mode and +VR mode. VR and video modes are available for DVD-RW discs while as only video mode is available for DVD-R discs. +VR mode is available for DVD+RW/+R discs.

Video mode is the same recording format as used on the pre-recorded DVD-videos you purchase in local shops. You can play back the discs recorded in this format in most of the DVD players. You will need to finalise such discs (see page 45) before playing them back in other DVD players. Unless finalised, you can record additional materials or edit discs recorded in video mode with this unit. VR (Video Recording) mode is a basic recording format for DVD-RW discs. VR mode offers advanced editing, and you can record and edit material repeatedly, however it is playable only on VR mode compatible unit. Finalisation is recommended before playing them back in other unit.

+VR mode is a recording format for DVD+RW/+R disc. +VR mode offers basic editing, and it is playable in most DVD players. Finalisation is recommended before playing them back in other unit.

### Recording Mode

You can select a recording mode from 5 options. The recording time will vary depending on the recording mode you select as follows.

Recording mode	Recording time			Video / Sound Quality
	DVD 12 cm	DVD 8 cm	HDD	
XP	60 min	18 min	68 hrs	☆☆☆☆☆
SP	120 min	36 min	136 hrs	☆☆☆☆
LP	240 min	72 min	272 hrs	☆☆☆
EP	360 min	108 min	409 hrs	☆☆
SLP	480 min	144 min	545 hrs	☆

- This table is intended for a standard new single-sided 12 cm / 8 cm disc. The recording times are estimates and actual recording time may differ.
- The audio and video quality becomes poorer as the recording time gets longer.

## Restrictions on Recording

You cannot record copy-protected video using this unit. Copy-protected video includes DVD-videos and some satellite broadcasts.

If copy-protected material is detected, recording will pause or stop automatically and an error message appears on the screen.

You can only record "Copy-once only" video using a DVD-RW disc in VR mode with Content Protection for Recordable Media (CPRM) or internal HDD.







When recording a TV broadcast or an external input, you can display copy control information on the screen.

CPRM is a scrambling copy protection system for the protection of "copy-once" broadcast programmes.

This unit is CPRM compatible, which means that you can record copy-once broadcast programmes, but you cannot then make a copy of those recordings. CPRM recordings can only be played back on DVD players that are specifically compatible with CPRM.

## Information on Copy Control

Some satellite broadcasts include copy-protected information. If you want to record them, refer to the following.

Media type / format	Copy-free	Copy-once	Copy-prohibited
 HDD	☆	☆	—
 VR DVD-RW	ver. 1.1 / ver. 1.2	☆	—
	ver. 1.1 / ver. 1.2 CPRM compatible	☆	☆
 Video DVD-RW	ver. 1.1 / ver. 1.2	☆	—
	ver. 1.1 / ver. 1.2 CPRM compatible	☆	—
 DVD-R	☆	—	—
 DVD+RW	☆	—	—
 DVD+R	☆	—	—
 VCR	☆	☆	☆

☆ : Recordable  
— : Not recordable

### Note

- This unit cannot record on CD-RW/-R discs.
- Discs recorded on a personal computer or a DVD or CD recorder may not be played back if the disc is damaged or dirty or if there is condensation on the recorder's lens.
- If you record a disc using a personal computer, even if it is recorded in a compatible format, it may not be played back or dubbed because of the settings of the application software used to create the disc. (Check with the software publisher for more detailed information.)
- Discs recorded in video mode on this unit cannot record additional information using other DVD recorders.
- Since recording is performed using the Variable Bit Rate (VBR) method, the actual remaining time for recording may be a little shorter than the remaining time displayed on the OSD, depending on the picture you are recording.

## Making Discs Playable in Other DVD Players (Finalise)

After recording, you must finalise the disc to play it back in other players. (See page 45.)  
You cannot finalise discs in other DVD recorders.

Disc Type	DVD-R	DVD-RW		DVD+RW	DVD+R
		Video Mode	VR Mode		
<b>After finalising</b>					
Automatic Title menu making	✓	✓		✓	✓
Undo finalising (See page 45.)		✓	✓		
Additional recording or editing (See page 45.)		✓ (undo finalise)	✓ (undo finalise)	✓	

✓: Available

Grey: Not available

## About HDD

HDD is a special device which has high recording density and is suited for long-time recording or high-speed cueing but by contrast, has many factors which can cause breakage. Use HDD on the premise that you should dub the recorded programmes to a DVD disc to protect your precious videos.

### HDD is a temporary storage location:

HDD is not a permanent storage location of the recorded contents. Be sure to use it as a temporary storage location until you watch the programmes once, edit them, or dub them to a DVD disc.

### Be sure to dub (back up) data promptly if you find abnormalities in HDD:

If there is mechanical trouble with the HDD, grinding or other sounds may be heard or blocky noise may appear on the image. If you continue to use as it is, deterioration may continue and eventually the HDD may not be used at all. If you notice these symptoms of a failing HDD, promptly dub the data to a DVD disc.

When an HDD fails, recovery of recorded content (data) may be impossible.

### About the remaining capacity of HDD recording time:

In recording to HDD, the Remaining Capacity Display may differ from the actual recordable time as this unit adopts Variable Bit Rate encoding, which varies the recording (storage) amount of data in conformity with the amount of information in the video signal. Before recording to the HDD, ensure there is sufficient space on the HDD by deleting unnecessary titles in advance. (Remaining capacity will not increase if you only delete Playlists.)

## Maximum Recordable Numbers of Title / Chapters

### HDD:

600 Original titles  
600 Playlists  
99 chapters per Original/Playlist title

### VR mode DVD:

99 titles per each Playlist and Original  
999 chapters per each Playlist and Original

### Video mode DVD:

99 titles per disc  
99 chapters per title

### +VR mode DVD:

49 titles per discs  
254 chapters per disc  
99 chapters per title

Introduction

Connections

Basic Setup /  
TV View Operation

Recording

Playback

Editing

Function Setup

VCR Functions

Others

## Formatting a Disc

### Choosing the Recording Format of a Blank DVD-RW Disc



When inserting a brand-new DVD-RW/+RW disc, the unit automatically starts to initialise the disc. DVD+RW disc will always be formatted in +VR mode, and DVD-RW disc will be formatted either video or VR mode according to the recording format mode setting of the unit. Before inserting a brand-new DVD-RW disc, you need to set the recording format to the desired mode. You can also manually format a DVD-RW disc once it has been used.

- 1 In stop mode, press [SETUP].
- 2 Select "DVD Menu" using [▲ / ▼], then press [ENTER/OK].
- 3 Select "Format" using [▲ / ▼], then press [ENTER/OK].
- 4 Select "Format Mode" using [▲ / ▼], then press [ENTER/OK].
- 5 Select "Video mode" or "VR mode" using [▲ / ▼], then press [ENTER/OK].

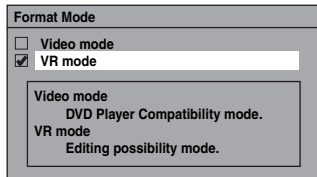

- 6 Press [SETUP] to exit.
- 7 Insert a blank disc.  
Formatting will start.
- 8 Formatting is complete.  
"100%" is indicated.

#### Note

- The recording format setting is effective only for DVD-RW discs. You cannot change the recording format for a DVD-R disc and DVD+RW/+R disc.
- You cannot mix two formats on one DVD-RW disc.
- If you insert a disc that has been formatted before, the recording format is not changed if you select another format in the "Setup" menu only. To reformat a disc (change disc format type), refer to "Reformatting a Disc Manually" on page 31.

## Make Recording Compatible



Use this feature to make the unfinalised +VR mode discs recorded on other unit recordable on this unit. When you make an additional recording on this unit with "Make Recording Compatible" set to "ON", the title list is automatically converted to this unit's style.

- 1 In stop mode, press [SETUP]. Select "General Setting" using [▲ / ▼], then press [ENTER/OK].
- 2 Select "Recording" using [▲ / ▼], then press [ENTER/OK].
- 3 Select "Make Recording Compatible" using [▲ / ▼], then press [ENTER/OK].
- 4 Select "ON" or "OFF" using [▲ / ▼], then press [ENTER/OK].

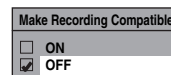

ON: Title list will be replaced when you make additional recordings to the discs recorded by other units.

OFF: Prohibiting additional record to the disc that has a title list created by other units.

- 5 Press [SETUP] to exit.

## Setting Aspect Ratio for Video Mode Recording



You can set aspect ratio for video mode recording.

- 1 In stop mode, press [SETUP]. Select "General Setting" using [▲ / ▼], then press [ENTER/OK].
- 2 Select "Recording" using [▲ / ▼], then press [ENTER/OK].
- 3 Select "Aspect Ratio (Video mode)" using [▲ / ▼], then press [ENTER/OK].
- 4 Select your desired setting using [▲ / ▼], then press [ENTER/OK].

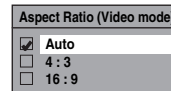

Auto: It will be recorded with whichever the ratio that the programme you started to record is broadcasted with.

4:3 : Recorded with the aspect ratio of 4:3.

16:9 : Recorded with the aspect ratio of 16:9.

- 5 Press [SETUP] to exit.

#### Note

- For HDD and VR mode DVD-RW disc, the image will be recorded in whichever the ratio that the programme you record is broadcasted with, regardless of the "Aspect Ratio (Video mode)" setting.
- For DVD+RW/+R disc, the image will always be recorded in aspect ratio of 4:3.

## Setting Auto Chapter



The unit inserts a chapter mark periodically (every 15 minutes by default) during recording. Using the Auto Chapter menu, you can set this function off or change the time period.

- 1 In stop mode, press [SETUP]. Select “General Setting” using [▲ / ▼], then press [ENTER/OK].
- 2 Select “Recording” using [▲ / ▼], then press [ENTER/OK].
- 3 Select “Auto Chapter” using [▲ / ▼], then press [ENTER/OK].
- 4 If you want to set “Auto Chapter” off, select “OFF” using [▲ / ▼], then press [ENTER/OK].

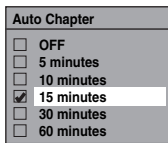

If you want to change the time period for “Auto Chapter”, select the required time period using [▲ / ▼], then press [ENTER/OK].

- 5 Press [SETUP] to exit.

### Note

- The interval for auto chapter may be up to 2 minutes different from the time option you set.
- While recording, no more chapter mark will be added after coming up to the maximum chapter mark number.

## Reformatting a Disc Manually



If you use a DVD-RW/+RW disc, you can format the disc by performing “Format”. You can format DVD-RW disc for either video mode recording or VR mode recording. DVD+RW disc can be formatted in order to erase all content of the disc.

### Note

- When you reformat the disc, the contents of the disc are erased.
- Make sure that the recording format is set to the desired mode. (Refer steps 1 to 6 in “Choosing the Recording Format of a Blank DVD-RW Disc” on page 30.)

### Insert a recordable disc.

- 1 In stop mode, press [SETUP].
- 2 Select “DVD Menu” using [▲ / ▼], then press [ENTER/OK].
- 3 Select “Format” using [▲ / ▼], then press [ENTER/OK].
- 4 Select “Start” using [▲ / ▼], then press [ENTER/OK].  
For DVD+RW, use [▲ / ▼] to select “Yes”, then press [ENTER/OK].

A pop up window will appear and prompt you to confirm.

- 5 Select “Yes” using [▲ / ▼], then press [ENTER/OK].

e.g.) VR mode DVD-RW

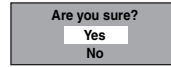

Formatting will start.

If you want to cancel formatting, select “No”.

- 6 Formatting is complete.

### Note

- It is not possible to use a disc formatted with another DVD recorder. The disc needs to be reformatted with this unit. But this unit may not be able to reformat some discs that are not previously formatted by this unit (e.g. DVD disc formatted by PC or another recorder).

## Selecting the Audio Mode

This unit can receive bilingual broadcasts.

You can switch between modes by pressing [AUDIO ]. Each mode is indicated on the TV. When you record a DVB channel, only output sound channel will be recorded.

## Setting External Input Audio



When the external input audio is a bilingual broadcast, you can choose “Stereo” or “Bilingual” to record on an HDD/DVD. This setting is only for recording external input (AV1/AV2).

- 1 In stop mode, press [SETUP]. Select “General Setting” using [▲ / ▼], then press [ENTER/OK].
- 2 Select “Recording” using [▲ / ▼], then press [ENTER/OK].
- 3 Select “External Input Audio” using [▲ / ▼], then press [ENTER/OK].
- 4 Select “Stereo” or “Bilingual” using [▲ / ▼], then press [ENTER/OK].

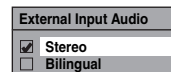

- 5 Press [SETUP] to exit.

### Note

- If you select “Stereo”:  
The audio will be recorded as “stereo audio”.
- If you select “Bilingual”:  
The audio will be recorded as “bilingual audio”. (See “Setting Bilingual Recording Audio” on page 32 for more detail.)

## Setting Bilingual Recording Audio



You can select either “Main” or “Sub” audio to record a bilingual broadcast in video mode or +VR mode. This setting is only for recording analogue channel.

- 1 In stop mode, press [SETUP]. Select “General Setting” using [▲ / ▼], then press [ENTER/OK].
- 2 Select “Recording” using [▲ / ▼], then press [ENTER/OK].
- 3 Select “Bilingual Recording Audio” using [▲ / ▼], then press [ENTER/OK].
- 4 Select “Main” or “Sub” using [▲ / ▼], then press [ENTER/OK].

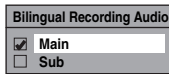

- 5 Press [SETUP] to exit.

### Note

- If you want to record onto an HDD or VR mode disc, both “Main” and “Sub” will be recorded regardless of your setting here. And when you play back, you can choose either audio format or a combination of both as your playback audio.

## Recording Audio Select (XP)



You can enjoy high quality sound recording. This function works only when the recording mode is set at XP.

- 1 In stop mode, press [SETUP]. Select “General Setting” using [▲ / ▼], then press [ENTER/OK].
- 2 Select “Recording” using [▲ / ▼], then press [ENTER/OK].
- 3 Select “Recording Audio Select (XP)” using [▲ / ▼], then press [ENTER/OK].
- 4 Select “PCM” or “Dolby Digital” using [▲ / ▼], then press [ENTER/OK].

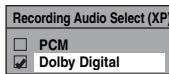

- PCM: Records PCM audio for the best quality sound.
- Dolby Digital: Records Dolby Digital audio for good quality sound.

- 5 Press [SETUP] to exit.

### Note

- “PCM” stands for Pulse Code Modulation. It changes analogue sound to digital sound without compressing audio data.
- When the recording mode is set at other than XP, the unit records “Dolby Digital” audio automatically even if you selected “PCM”.

## Basic Recording and One-touch Timer Recording (OTR)



Follow the steps below to record a TV programme. (See page 74 for VCR recording.)

- 1 Press [I/ON/STANDBY] to turn on the unit. Turn on the TV and be sure to select the input to which the unit is connected.
  - If you want to record to the HDD, press [HDD], then proceed to step 5.
  - If you want to record to a disc, press [DVD].
- 2 Press [OPEN/CLOSE ▲] to open the disc tray.
- 3 Place the disc on the disc tray with its label facing up. Be sure to align the disc with the disc tray guide.

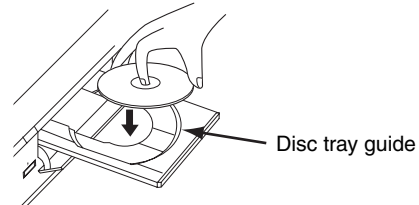

- 4 Press [OPEN/CLOSE ▲] to close the disc tray.
- 5 Select the recording mode using [REC MODE]. (See page 28.)
- 6 Press [INPUT SELECT ⇄] to select DVB, analogue or external input mode, then select the desired channel to record using [PROG. ^ / v] or [the Number buttons].

### Basic Recording:

Press [REC ●] to start recording. The “● HDD” or “● DVD” mark will be displayed on the TV screen briefly.

To pause the recording, press [PAUSE II]. Press [PAUSE II] or [REC ●] again to restart the recording.

### One-touch Timer Recording (OTR):

This is a simple way to set the recording time in blocks of 30 minutes. Check that the disc you are recording onto has enough space remaining for the time you set. (See page 74 for VCR recording.)

Press [REC ●] repeatedly until the desired recording time (30 minutes to 8 hours) appears on the TV screen.

One-touch Timer Recording will start.

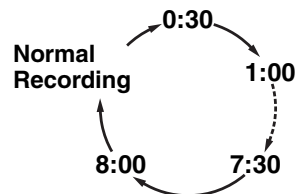



- When the unit reaches the specified time, it will be turned off automatically.
- To change the recording length during One-touch Timer Recording, press **[REC ●]** repeatedly until the desired length appears.
- To cancel One-touch Timer Recording within the specified time, press **[STOP ■]**.

### 8 Press **[STOP ■]** to stop the recording.

This operation may take a few moments to complete.

#### Note

- You can change the channel while in the REC pause mode.
- Recording continues until the disc is full (as for HDD, 12 hours after the recording starts) or you stop the recording.
- You cannot change the recording mode in the REC or REC pause mode.
- Even if the broadcasting you are recording is in the SECAM system, this unit automatically converts it to the PAL system when recording.
- You can play back a title on one component while making a recording on the other component. To do so, simply select the component (HDD or DVD) you want to use for the playback by pressing **[HDD]** or **[DVD]** during HDD / DVD recording. And then follow the normal playback procedure.
- If playback and recording are operated in each component (HDD or DVD) at the same time, select the component you want to operate first, and then press **[PAUSE II]** or **[STOP ■]**.
- NTSC recording is prohibited in this unit.
- The remaining recording time will appear on the TV screen during One-touch Timer Recording. Press **[DISPLAY]** to see it on the TV screen.
- The remaining recording time will be displayed on the front panel display during One-touch Timer Recording.
- Unlike the timer recording, you can perform the following operations during One-touch Timer Recording.
  - Turn off the power. (One-touch timer recording will be cancelled.)
  - Use **[REC ●]** or **[STOP ■]** on the remote control.
- You cannot use the pause function during One-touch Timer Recording.
- The unit will be turned off automatically under the following conditions.
  - No space remains on the disc.
  - If a power failure occurs.

## Timer Recording



You can set the unit to record up to 36 programmes, up to a month in advance. Daily or weekly programme recordings are also available.

- Be sure to set the clock before entering a timer programming.

### Insert a recordable disc.

- 1 In stop mode, press [TIMER PROG.]**.  
“Timer Programming” list will appear.
- 2 Select “New Programme” using [▲ / ▼], then press [ENTER/OK].**

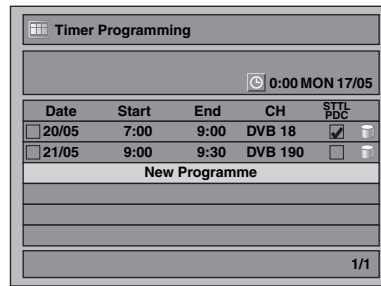

- If there are 6 programmes or more, use **[SKIP ◀◀ / ▶▶]** to turn the page.

- 3 Enter the date using [▲ / ▼], then press [▶].**  
Each time you press **[▼]** at the current date, the timer recording date will change as follows.

e.g., 1st January

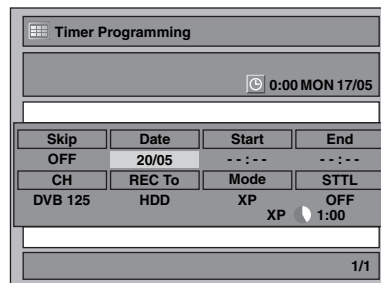
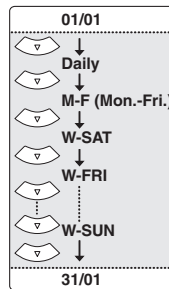

- Analogue channel is indicated as “ATV”.

- 4 Enter the time to start and to end using [▲ / ▼], then press [▶].**

- 5 Select the digital (DVB) / analogue (ATV) mode or external input (AV1/AV2) using [**▲** / **▼**], then press [**▶**].
- 6 Select the channel number to record using [**▲** / **▼**], then press [**▶**].
- 7 Select the recording media ("HDD" or "DVD") using [**▲** / **▼**], then press [**▶**].
- 8 Select the recording mode using [**▲** / **▼**], then press [**▶**].

Refer to "Recording Mode" on page 28.

### 9 For DVB channel recording:

Select "STTL" to "ON" or "OFF" using [**▲** / **▼**].

If you set "STTL" to "ON", subtitle will be recorded too.

- When analogue channel is selected, "PDC" will be displayed instead of "STTL".

### For analogue channel recording:

Select "PDC" to "ON" or "OFF" using [**▲** / **▼**].

Refer to "PDC (Programme Delivery Control)" on this page.

- When DVB channel is selected, "STTL" will be displayed instead of "PDC".
- PDC system is only available for HDD.
- PDC system is not available for "Daily" and "M-F" timer programme.

### 10 Press [ENTER/OK] when all information required is entered.



Your programme setting is stored.

- To set another programme, repeat steps 2 to 10.
- To exit, press [TIMER PROG.].
- When 2 or more programmes are overlapped, "Timer programme overlapped" appears, and the overlapped programme will be displayed in blue. To correct the timer programme, refer to "Checking, Cancelling or Correcting the Timer Programming Information" on this page.

Date	Start	End	CH	STTL PDC
20/05	7:00	9:00	DVB 18	☑
21/05	9:00	9:30	DVB 190	☐
22/05	17:00	18:00	1 BBC1	☐

New Programme

1/1

The  icon will appear on the front panel display. (When the unit is turned off, the  icon also goes off.)

#### Note

- If you have not set the clock, the clock setting window will appear instead of the Timer Programming list. Continue from "Clock Setting" on page 71 before programming the timer.
- Press [**▲** / **▼**] to move the cursor in "Timer Programming" list.
- If you have a timer programme with PDC function, and if you are watching different channel from the timer programme, confirmation message to change the channel will appear 15 minutes before the programme starts (the message will also re-appear 30 seconds before the programme starts). The channel will automatically be changed to the programmed channel 15 seconds before the programme starts.

#### Alternate recording (DVD only)...

If there is no recordable disc in the unit, if the disc does not have enough space to complete the recording, or if the material is "copy-once" programme and prohibited to be recorded on a DVD in the unit, the unit will detect it and automatically record to the HDD even when DVD is selected as the recording media. If the available space on the HDD is less than that of DVD, the unit will not perform the alternate recording. This feature is available only for timer recording. Not available for one-touch timer recording.

### PDC (Programme Delivery Control)

The Programme Delivery Control (PDC) assures that the TV programmes you have programmed for timer recording are recorded exactly from beginning to end, even if the actual broadcasting time differs from the scheduled time due to a delayed start or extension of the programme duration. Furthermore, if a programme is interrupted, the recording will also be interrupted automatically and resumed when the programme starts again.

If the PDC signal drops out because the broadcast signal is weak, or if a broadcasting station does not transmit a regular PDC signal, the timer recording is performed in normal mode (without PDC) even if it was programmed for PDC. If the starting time of the PDC timer recording is between 0:00 and 3:59 on a given day, the PDC function will operate from 20:00 on the previous day to 4:00 on the next day. If the starting time of the PDC timer recording is between 4:00 and 23:59 on a given day, the PDC function will operate from 0:00 on the given day to 4:00 on the next day. This means that if the relevant programme is broadcasted within this period, it is recorded correctly. If the timer is not programmed correctly, the incorrect timer setting stays in effect unless you cancel it. To cancel an incorrect timer setting, refer to "Checking, Cancelling or Correcting the Timer Programming Information" on this page.

#### Note

- This feature is only available for analogue channels.
- If DVB channels have been stored in this unit, you cannot select PDC on.

### Checking, Cancelling or Correcting the Timer Programming Information

#### 1 Press [TIMER PROG.].

#### 2 A) To delete the timer programme:

- 1) Select the programme you want to delete using [**▲** / **▼**], then press [ENTER/OK].
- 2) Select "Delete" using [**▲** / **▼**], then press [ENTER/OK].  
Confirmation window will appear.
- 3) Select "Yes" using [**▲** / **▼**], then press [ENTER/OK].

#### B) To correct the timer programme:

- 1) Select the programme you want to correct using [**▲** / **▼**], then press [ENTER/OK].
- 2) Select "Programme Change" using [**▲** / **▼**], then press [ENTER/OK].
- 3) Correct the timer programme by using [**▲** / **▼** / **◀** / **▶**], then press [ENTER/OK].

#### 3 Press [TIMER PROG.] to exit.

To check the timer programming in progress

Press [TIMER PROG.].

#### Note

- For EPG timer recording, you can only correct the "REC To", "Mode" and "STTL".

## Skip the Periodical Timer Recording

You can deactivate the periodical (Daily, Mon-Fri or Weekly) timer recording temporarily.

- 1 In stop mode, press [TIMER PROG.].
- 2 Select the periodical timer recording programme you want to skip using [▲ / ▼], then press [ENTER/OK].
- 3 Select "Programme Change" using [▲ / ▼], then press [ENTER/OK].
- 4 Move the cursor to the "Skip" field using [◀ / ▶], then select "ON" using [▲ / ▼] and then press [ENTER/OK] to activate the setting.

- "✓" will be displayed on the left side of the timer programme.
- The setting will go back to "OFF" after the programme is skipped once.

## Stop the Timer Recording in Progress

On the front panel:

Press [STOP ■].

On the remote control:

- 1 Press [STOP ■].
- 2 Select "Yes" using [▲ / ▼], then press [ENTER/OK].

## If the Timer Programming did not Complete Correctly

The error number appears on "Timer Programming" list.

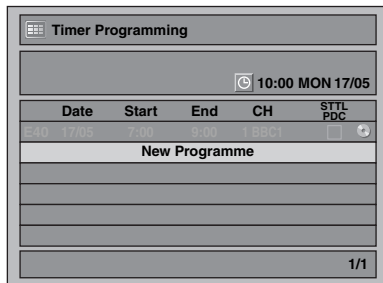

The error programme will be displayed in grey with an error number.

The error numbers indicate:

E1–E22, E37–E39	Recording error
E23–E24	Unrecordable disc
E25/E51	<ul style="list-style-type: none"> <li>• Copy prohibited programme</li> <li>• Cannot record because of the NTSC / PAL-60 signal is received.</li> </ul>
E26–E28	Copy prohibited programme
E29	Disc protected
E30	Disc full
E31	Already recorded 99 titles (video mode)
E32	Already recorded 99 titles (VR mode)
E33	Already recorded 999 chapters
E34	No space for Control Information
E35	PCA (Power Calibration Area) full
E36	Already finalised video format disc

E40	<ul style="list-style-type: none"> <li>• There are some unrecorded parts due to the overlapped timer programmes.</li> <li>• Recording did not start at the start time.</li> </ul>
E41	Power failure
E42	No disc
E43	Already 49 titles recorded (+VR mode)
E44	Already 254 chapters recorded (+VR mode)
E45	Copy prohibited programme
E46	It is impossible to record additionally on a disc recorded by other units when setting "Make Recording Compatible" to "OFF". (+VR mode)
E47	Already 600 titles recorded on the HDD.
E49–E50	HDD recording is cancelled due to the insufficiency of the disc space on the HDD.

- Timer programme with an error number will be cleared once the entry screen for the programme is displayed.

## Notes for the Timer Recording

- If there is a power failure or the unit is unplugged for more than 30 seconds, the clock setting and all timer settings will be lost.
- If a disc is not inserted or if a inserted disc is not recordable (finalised DVD-RW/-R, finalised DVD+R, a fully recorded disc, etc.), the unit will perform the alternate recording to the HDD. (See page 34.)
- When a timer recording is completed, the unit will ask you whether to turn off the unit if there is no timer recording which starts within 4 minutes, except under conditions listed below.
  - During playback of HDD or DVD.
  - While displaying menus or information on the screen. The unit will be turned off automatically if you select "Yes" or if you do not reply in 1 minute.
- When the programmed starting and ending time are earlier than the current time, the setting will not be accepted.
- The audio language which is selected in the "DVB Setting" will be recorded for digital TV broadcasting.
- Timer recording whose recording time exceeds 12 hours cannot be made.
- It is prohibited to turn off the unit from 4 minutes before the programmed starting time.
- It is prohibited to change channel from 15 seconds before the programmed starting time.
- [REC ●] does not work from 2 minutes before the programmed starting time. If it comes to 2 minutes before the starting time during regular or one-touch timer recording, the recording in progress will be stopped.
- Playback of DVD/CD is prohibited from 2 minutes before the programmed starting time when the recording media is DVD. If it comes to 2 minutes before the programmed starting time during DVD/CD playback, the playback will be stopped.
- When 2 or more programmes are overlapped, "Timer programme overlapped" appears, and the overlapped programme will be displayed in blue. To correct the timer programme refer to "Checking, Cancelling or Correcting the Timer Programming Information" on page 34.
- If the Start time is earlier and the End time is later than the current time, the recording will start immediately after you press [ENTER/OK] at step 10 on page 34.
- As to the timer recording in progress (which is shown in red in the timer programme list), you only can edit the end time. The changes made during recording will be recognised as only specific to that recording in progress and it will not affect the daily or the weekly recording setting.

**Priority of overlapped settings**

The unit records programmes according to priority if the timer programmes overlap.

**If the starting time is same:**

- The timer programming set first (PROG. 1) has priority.

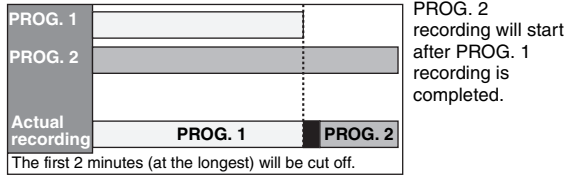

**If the End time of the programme currently being recorded and the Start time of the subsequent programme are same:**

- If PROG. 1 is a DVD recorded programme, the beginning of the PROG. 2 may be cut off.

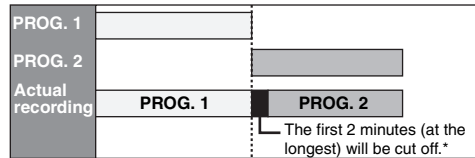

\* If the cut off time exceeds 3 minutes, the error number "E40" will appear in "Timer Programming" list.

**When the starting time and the ending time for each programmes are different:**

- A programme that has earlier start time has priority.

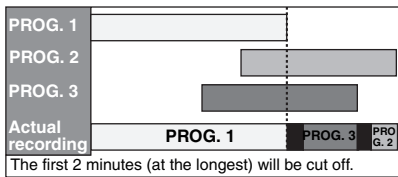

**If the recording time is partially overlapped:**

- The timer programming with the earlier start time (PROG. 2) has priority. PROG. 1 will start after PROG. 2 recording is complete.

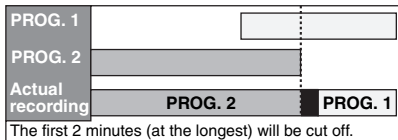

**If the recording time entirely overlaps:**

- The shorter timer programming (PROG. 1) is not recorded.

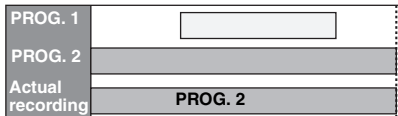

**Note for DVD recording**

- If the recording time of two programmes are overlapped, or the End time of a programme and the Start time of another is same, the first 2 minutes (at the longest) of the subsequent programme will be cut off.

**Timer Recording (EPG)**



With EPG system, you can programme DVB channel recording much easier. You can only choose one programme and enter the selection.

Refer to "EPG (Electronic Programme Guide)" on page 27.

**1 While viewing a DVB programme, press [GUIDE].**

List of DVB programmes will be displayed.

e.g.) Daily Mode

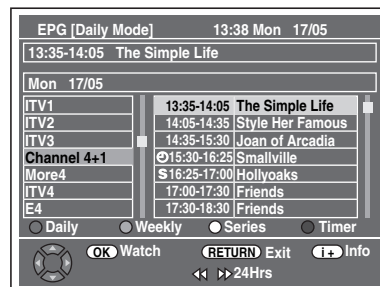

Press [RED] to display "Daily Mode".  
Press [GREEN] to display "Weekly Mode".

**2 Select a desired programme using [▲ / ▼ / ◀ / ▶], then press [ENTER/OK] or [BLUE].**

**3 Set "REC To", "Mode" and "STTL" using [▲ / ▼ / ◀ / ▶], then press [ENTER/OK].**

**Note**

- EPG timer recording will stop if the broadcaster sends the EPG programme end or if you press [STOP ■] on the front panel or press [STOP ■] on the remote control, then select "Yes" using [▲ / ▼], then press [ENTER/OK].
- If you select a programme that is broadcasting in progress, "Watch" is indicated next to (OK). When you press [ENTER/OK], you can watch the selected programme.
- If you select a programme that is not broadcasted yet, "Timer" is indicated next to (OK). When you press [ENTER/OK], you can set "Timer Recording".

## Series Link Timer Recording



With the EPG system, when you set a TV programme into the timer recording, you can also set for future episodes of that series to be recorded. It is also possible to set for the broadcaster to recommend related programmes to you.

- 1 While viewing a DVB programme, press [GUIDE].**
  - List of DVB programmes will be displayed.
- 2 Select a desired programme using [▲ / ▼ / ◀ / ▶], then press [YELLOW].**
  - Other series of the TV programme and recommended programme related to the TV programme will be displayed in "Series List".
- 3 Press [BLUE] or [ENTER/OK].**
  - Press [BLUE] to set the programme only once for Timer Recording.
  - Press [ENTER/OK] to set all the series for the Series List Timer Recording.



- Use the scroll bar using [▲ / ▼], then press [INFO] to see more detailed information of the selected programme.
- If the programmes in "Series List" are already set for timer recording, "S" will be displayed.
- "♥" refers to recommended programme related to the TV programme.

- 4 Set "REC To", "Mode" and "STTL" using [▲ / ▼ / ◀ / ▶], then press [ENTER/OK].**
  - In "Timer Programming" list, "S" will be displayed for the Series Link Timer Recording programmes.

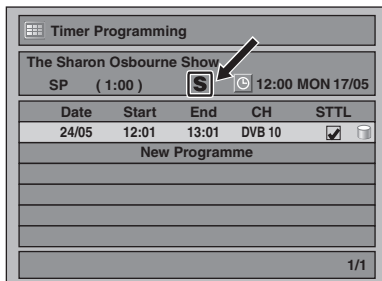

### Note

- If you delete or correct a series link timer recording programme, all programmes related to the programme will be deleted or corrected.
- [YELLOW] is available only when the selected programme has the series link tag.
- Series Link Timer Recording always starts from the first available date. If you want to record on specific dates only of the series, please use normal Timer Recording.

### Recording split programmes

Some TV programmes are split into 2 or more parts. With EPG system, when you set the first part of the split TV programme for the timer recording, whole parts will be set to the timer programme automatically.

### Alternate instance recording

If a timer programming you set overlaps, this unit will search for same TV programme broadcasted in different time, and if this unit finds the programme, you will be asked whether to record the programme in different time instead.

## Satellite Link



You can set the unit to start recording whenever it detects the video start control from the external tuner.

### Preparing for the Satellite Link Timer Recording:

#### [Preparation of the external tuner]

- The external tuner should be equipped with some kind of timer function. Using timer function of the tuner, set it to be turned on when it comes to the time you want to start recording, and off when it comes to the time you want to finish recording. (Refer to the tuner's manual on how to set the timer.)
- Make sure to turn off the external tuner when you finish setting.

#### [Preparation of this unit]

- Make sure to select the desired recording mode beforehand.

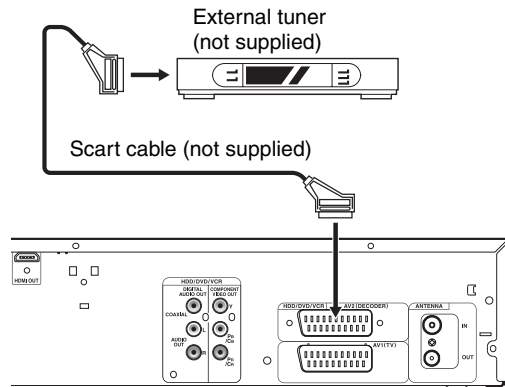

- 1 In stop mode, press [HDD] then select the recording mode for HDD using [REC MODE].**

## 2 Press [SAT.LINK].

- "Sat" will appear on the front panel display and the unit goes into the satellite link standby mode.



**To cancel the satellite link function in the satellite link standby mode:**

Press [I/O] ON/STANDBY or [SAT.LINK] to turn on the unit.

**To cancel the satellite link function while the satellite link recording is in progress:**

**On the front panel**

Press [STOP ■].

**On the remote control**

1 Press [STOP ■].

2 Select "Yes" using [▲ / ▼], then press [ENTER/OK].

### Note

- Recording picture will be distorted if the copy protection signal is being detected during satellite link timer recording.
- [SAT.LINK] does not work under the following circumstances:
  - Setup menus are displayed.
  - "Timer Programming" menu is displayed.
  - Title list or any file list is displayed.
  - During timer recording (counting from 4 minutes before the starting time).
  - During playback of HDD, DVD or VCR.
  - During recording or dubbing of HDD, DVD or VCR.
- When a regular timer recording and the satellite link timer recording are overlapped, the examples are given below.

	Example 1
Timer Recording	
Satellite Link	
Actual Recording	

	Example 2
Timer Recording	
Satellite Link	
Actual Recording	

	Example 3
Timer Recording	
Satellite Link	
Actual Recording	

## Settings for External Equipment

### Video Colour System

When you record from external equipment or copy a videotape to an HDD/DVD disc, you can set the format Auto, PAL or SECAM.

- 1 In stop mode, press [SETUP]. Select "General Setting" using [▲ / ▼], then press [ENTER/OK].
- 2 Select "Recording" using [▲ / ▼], then press [ENTER/OK].
- 3 Select "Video Colour System" using [▲ / ▼], then press [ENTER/OK].
- 4 Select "Auto", "PAL" or "SECAM" using [▲ / ▼], then press [ENTER/OK].

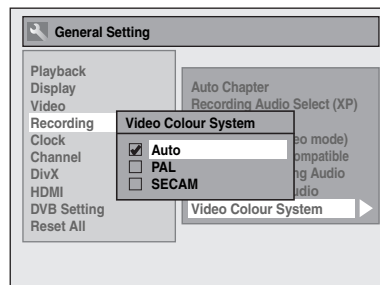

**Auto:** The video colour system will be set automatically according to the recording material.

**PAL:** The video colour system will be set to PAL.

**SECAM:** The video colour system will be set to SECAM.

### 5 Press [SETUP] to exit.

#### Note

- During recording, when a signal other than PAL or SECAM is detected, an error message appears on the screen and recording will be paused. Recording will be resumed when a PAL or SECAM signal is detected.

## Recording from External Equipment



Before recording from external equipment, see page 19 for connection instructions.

- 1 Turn on the TV and be sure to select the input to which the unit is connected.
  - If you want to record to the HDD, press [HDD].
  - If you want to record to a disc, press [DVD] and insert a recordable disc.
  - If you want to record to a videotape, press [VCR] and insert a recordable videotape.
- 2 Select the input terminal to which the external equipment is connected (AV1 or AV2).
 

Press [INPUT SELECT] repeatedly to select the external input mode, then press [PROG. ▲ / ▼] repeatedly to select AV1 or AV2.
- 3 Select a recording mode using [REC MODE]. (See page 28.)
- 4 Press [● REC] on the unit to start recording.
- 5 Press the [PLAY ►] button on the external equipment.

**6 Press [STOP ■] (HDD/DVD) or [STOP/EJECT ■ / ▲] (VCR) on the unit to stop recording.**

**Note**

- During recording, recording will be paused when a signal other than PAL or SECAM is detected. (See "Video Colour System" on page 38 for details.)
  - The signal from the external device will be output automatically when the TV is connected to AV1 and the external device is connected to AV2 using a Scart cable with its power on. (However, it will not be output when this unit's power is turned off.)
- If you want to monitor this unit's signal, press [DISPLAY] or turn the external device off. (The signal from this unit can only be monitored during playback.)**
- If you want to monitor the signal from other input, press [DISPLAY], then press [INPUT SELECT ⇄] to select the desired external input mode, then select the desired input channel using [PROG. ▲ / ▼].**

**Information on DV Dubbing**

This function helps you to dub the contents in the DVC (digital video camcorder) to HDD, DVD or VCR easily. (See page 75 for DVC to VCR Dubbing.)  
You can control basic operations of the DVC from the remote control of this unit if the DVC is in video mode.

**Guide to DV and On-Screen Display**

- 1 Connect your DVC to the DV input jack on the front panel using a DV cable. (Use the DV cable that has 4-pin input jack and is compliance with the IEEE 1394 standards.)**
- 2 Press [INPUT SELECT ⇄] repeatedly to select the external input channel, then press [PROG. ▲ / ▼] repeatedly to select DV(AV3).**
- 3 Press [DISPLAY] to display the DVC information on the screen.**

When the DVC is in video mode...

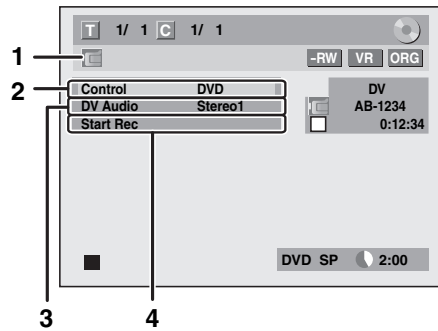

When the DVC is in camera mode...

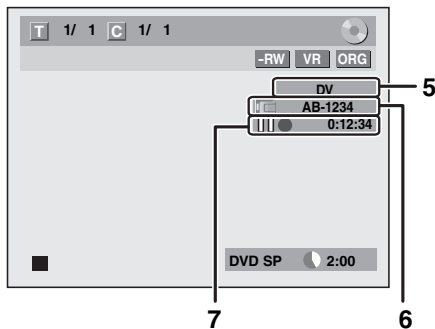

The menu changes according to the mode of DVC. Switch the mode on the DVC to video mode for the dubbing information.

The following instructions are described with the operations using the remote control of this unit.

- 1 DV icon**
- 2 Indicator of active device**
  - With "Control" highlighted, press [ENTER/OK] to display the available devices to control with the remote control of this unit. Select the device you want to operate using [▲ / ▼], then press [ENTER/OK].
  - Select "HDD" / "DVD" to control this unit with the remote control of this unit.
  - Select "DVC" to control your DVC with the remote control of this unit.
- 3 Recording audio mode**
  - "DV Audio" can be changed. With "DV Audio" selected, press [ENTER/OK] to display "DV Audio" menu. Select the audio you want to output using [▲ / ▼], then press [ENTER/OK].
  - Select "Stereo1" to dub the stereo sound.
  - Select "Stereo2" to dub the sound that was added after the recording.
  - Select "Mix" to dub the stereo1 and stereo2.
- 4 Command menu**
  - "Start Rec" or "Pause Rec" will appear.
- 5 External input channel**
- 6 Product name of your DVC**
  - If the unit cannot recognise the input signal from the DVC or if it is the unknown product, "No Device" or "\*\*\*\*\*" will appear instead.
- 7 Status of the current operation and the time counter**

Each icon means (Available icons may vary depending on the DVC):

- DVC is in stop mode.
- ▶ DVC is in playback mode.
- || DVC is in pause mode.
- ▶▶ DVC is fast forwarding. (standard speed)
- ▶▶▶ DVC is fast forwarding. (faster than above)
- ▶▶▶▶ DVC is fast forwarding. (faster than above)
- ||▶▶ DVC is slow forwarding. (standard speed)
- ||▶▶▶ DVC is slow forwarding. (faster than above)
- ||▶▶▶▶ DVC is slow forwarding. (faster than above)
- ▶▶▶▶▶ DVC is fast forwarding. (in stop mode)
- ◀◀ DVC is fast reversing. (in stop mode)
- ▶▶◀ DVC is fast reversing. (standard speed)
- ▶▶◀▶ DVC is fast reversing. (faster than above)
- ▶▶◀▶▶ DVC is fast reversing. (faster than above)
- ||▶◀ DVC is in slow reverse playback.
- DVC is in recording.
- ||● DVC is in recording pause mode.

Please also read the operating instructions of your DVC for more information.

Introduction

Connections

Basic Setup /  
TV View Operation

Recording

Playback

Editing

Function Setup

VCR Functions

Others

## DVC to HDD / DVD Dubbing



Before recording from DVC, see page 19 for connection instructions. (See page 75 for DVC to VCR Dubbing.)

### Preparing for DV dubbing (DVC to HDD):

- Make sure your DVC is in video mode.

### Preparing for DV dubbing (DVC to DVD):

- Insert a recordable DVD.
- Make sure your DVC is in video mode.

If you want to record to the HDD, press [HDD] first.

If you want to record to a disc, press [DVD] first.

- 1 Press [INPUT SELECT ] repeatedly to select the external input channel, then press [PROG. / ] repeatedly to select DV(AV3).

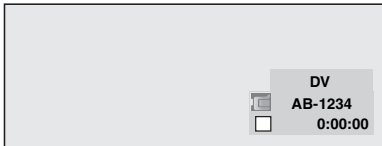

- 2 Press [REC MODE] to select a recording mode. (See page 28.)
- 3 Press [DISPLAY].
- 4 With "Control" highlighted, press [ENTER/OK] to display the available devices to control with the remote control of this unit. Select "DVC" using [ / ] , then press [ENTER/OK].

e.g.) DVC to DVD dubbing

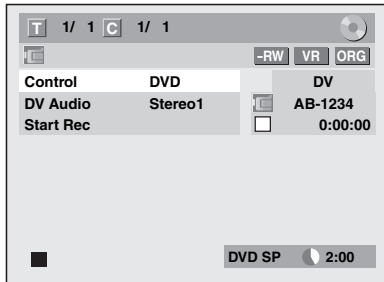

Now you can operate your DVC with the remote control of this unit.

- 5 Press [PLAY ] to start playing back the DVC, and find where you want to start dubbing. Press [STOP ] when it comes to the desired start point.
- 6 Select "Start Rec" using [ / ] , then press [ENTER/OK].

The dubbing will start.

### To stop dubbing:

- 1) Select "Control" using [ / ] , then press [ENTER/OK].
- 2) Select "HDD" / "DVD" using [ / ] (whichever the recording component you are using), then press [ENTER/OK].
- 3) Press [STOP ].

### Note

- The tape will rewind a few seconds when you press [ENTER/OK] at step 6 so that the dubbing starts exactly where you press [PAUSE ] instead of [STOP ] at step 5.
- The unit does not send out the output signal to DVC.
- For the proper operation, connect DVC to the unit directly. Do not connect this unit and DVC via any other unit.
- Do not connect more than one DVC.
- The unit can only accept DVC. Other DV device such as cable/satellite box or D-VHS recorder cannot be recognised.
- If no video signal is detected from the DVC during DVC to HDD or DVD dubbing, the recording will be paused and "●" will flash on the TV screen. The recording will resume when the unit detects the video signal again.
- When the DVC is in camera mode, refer to "Guide to DV and On-Screen Display" on page 39.
- Date / time and cassette memory data will not be recorded.
- Pictures with a copy-guard signal cannot be recorded.
- A DV terminal is a terminal that can use the transmission mode conforming to the IEEE 1394 standards called "Fire Wire". It serves as the interface that connects the PC and peripheral device such as "i.LINK" (registered trademark of SONY). It enables digital dubbing between DV devices with little degradation.
- You cannot dub from DVC to both HDD and DVD at the same time.

## Information on Dubbing

You can copy an HDD / DVD disc to a videotape or copy a videotape to an HDD / DVD disc. This function will be possible only if the DVD or the videotape is not copy protected. Before dubbing, prepare for the recording on the DVDs or the videotape. See pages 28 to 29 (HDD / DVD) or page 74 (VCR).

### Difference between "Copy" and "Move":

Copy : After dubbing the programme, the original programme will remain.

Move: After dubbing the programme, the original programme will not remain.



**Available dubbing direction for copy-once programme:**

From	To	
HDD (Internal)	DVD-RW (VR) (CPRM-compatible)	○ <sup>*1,2</sup>
	DVD-RW (VR) (Not CPRM-compatible)	×
	DVD-RW (video)	×
	DVD-R / +RW / +R	×
	Videotape	○ <sup>*2</sup>
DVD-RW (VR)	HDD (Internal)	×
	Videotape	○ <sup>*2</sup>
Videotape	HDD (Internal)	○
	DVD-RW (VR) (CPRM-compatible)	○ <sup>*2</sup>
	DVD-RW (VR) (Not CPRM-compatible)	×
	DVD-R / +RW / +R	×

○: Available  
 ×: Not available

- \*1 The recorded programme moves.  
 \*2 You cannot dub the recorded programme to HDD or DVD-RW again. (Copy control signal will be recorded to the videotape.) (Refer to page 28 for details about CPRM.)

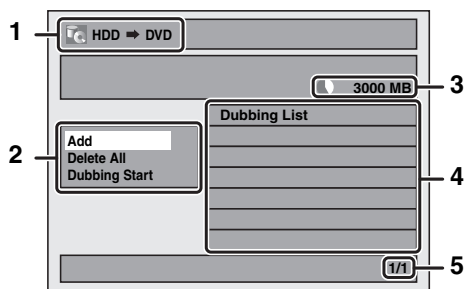
**Guide to Dubbing Menu Display**

- Dubbing direction**
- Dubbing menu**
- Remaining recordable space**
- Dubbing list**
- Current page number / total number of pages**

**Recording Mode for Dubbing****“High”**

This unit is compatible with the high speed dubbing from HDD to DVD or VR mode DVD-RW disc to HDD. With the high speed dubbing, you can dub a title much faster than the normal speed dubbing without changing the quality of the picture and sound. (e.g. If you dub a title recorded in SLP mode to DVD-R, dubbing speed will be 32 times faster than the normal dubbing speed.) To perform the high speed dubbing, set the recording mode to “High”.

- Duration of high speed dubbing will vary depending on the recording mode or the title amount.
- High speed dubbing is not available when;
  - recording mode is set to other than “High”.
  - dubbing from a video mode DVD-RW/-R or DVD+RW/+R disc to the HDD.
  - there is not enough space in the disc.
  - dubbing a title recorded in EP or SLP mode to DVD+RW/+R discs.
- High speed dubbing of an HDD title which has bilingual audio is only available to VR mode DVD-RW disc.

**“Auto”**

When “Auto” is selected as a recording mode, the unit calculates how much time is available on the disc and selects the best recording mode available automatically.

- The recording may be cut short when the available recording space of the disc is too limited.

**Note**

- During normal dubbing, you can watch the playback picture of the title being dubbed (the audio cannot be changed). During high speed dubbing, the playback picture will not appear.
- When you dub an HDD title that has bilingual audio to video mode DVD-RW/-R or DVD+RW/+R disc, select an appropriate audio format in the “Bilingual Recording Audio” menu. Refer to “Setting Bilingual Recording Audio” on page 32.
- In order to dub a DVD recorded with the NTSC, set the “TV System” to “PAL”. Refer to “[TV System (Default: PAL) (DVD only)]” on page 70.
- If you stop the dubbing halfway, the contents will be dubbed up to where you stop the dubbing (except for the high speed dubbing). With high speed dubbing, nothing will be dubbed if you stop it halfway.
- To stop the dubbing in progress, press **[STOP ■]** (for HDD to DVD, DVD to HDD and VCR to HDD/DVD) or **[STOP/EJECT ■ / ▲]** (for HDD/DVD to VCR) on the front panel or press **[STOP ■]** for 2 seconds on the remote control. If you stop the high speed dubbing or stop the dubbing copy-once programmes, confirmation message appears. Select “Yes” using **[▲ / ▼]**, then press **[ENTER/OK]** to proceed.

**Other recording modes**

Refer to page 28 for the information on other recording modes.

**Before Starting Dubbing****HDD to DVD / DVD to HDD**

You can copy the contents between HDD and DVD.

**Limitation (DVD to HDD):**

- If a copy control signal is detected during dubbing, the dubbing will be stopped.

**Preparing for dubbing (HDD to DVD):**

- Insert a recordable DVD.

**Preparing for dubbing (DVD to HDD):**

- Insert a disc to be dubbed.
- Discs dubbed with other devices may not be dubbed.

Introduction

Connections

Basic Setup /  
TV View Operation

Recording

Playback

Editing

Function Setup

VCR Functions

Others

### VCR to HDD / DVD

You can copy the contents of a videotape to HDD or DVD disc.

#### Limitation:

- If a copy control signal is detected during dubbing, the dubbing will be stopped.
- Copy-once programmes which are recorded directly from the TV can be dubbed to the HDD and CPRM compatible VR mode DVD-RW.
- Copy-once programmes which are copied from the HDD / DVD to a videotape cannot be dubbed further from the videotape to the HDD / DVD.

#### Limitation (VCR to HDD):

- With VCR to HDD dubbing, the unit recognise the HDD's remaining time as the dubbing duration. The maximum possible duration is 12 hours.

#### Limitation (VCR to DVD):

- You cannot dub to the finalised video mode DVDs.
- You cannot dub to the protected VR mode DVDs.

#### Preparing for dubbing:

- Insert a videotape to be dubbed.

#### Preparing for dubbing (VCR to HDD):

- Make sure there is enough space on the HDD.

#### Preparing for dubbing (VCR to DVD):

- Insert a recordable DVD.
- Make sure there is enough space on the DVD.

### HDD / DVD to VCR

You can copy the contents of the HDD / DVD to a videotape.

#### Limitation:

- If a copy control signal is detected during dubbing, the dubbing will be stopped.

#### Limitation (DVD to VCR):

- The contents of DVDs made on this unit can be dubbed. Other discs may not be dubbed.

#### Preparing for dubbing:

- Insert a recordable videotape with a record tab intact.
- Make sure that the videotape has enough space to record the contents.

#### Preparing for dubbing (DVD to VCR):

- Insert a disc to be dubbed.

### One Touch Dubbing



You can start dubbing right away with just one touch.

### One Touch Dubbing between HDD and DVD



If you want to record a title in the HDD, press [HDD] first.

If you want to record a title in a disc, press [DVD] first.

During playback of the title you want to dub, press [DUBBING].

If you are playing back an HDD, HDD to DVD dubbing will start right away.

If you are playing back a DVD, DVD to HDD dubbing will start right away.

#### (HDD to DVD only)

During playback of the title you want to dub, press [DUBBING HDD > DVD] on the front panel. HDD to DVD dubbing will start right away.

#### To stop the dubbing in progress:

Press [STOP ■] on the front panel.

Press [STOP ■] for 2 seconds on the remote control.

#### Note

- When dubbing from DVD to HDD, only One Touch Dubbing will be available for finalised DVD-R, video mode DVD-RW or DVD+R.
- The dubbing will start from the beginning of the title being played back.
- The unit will dub only the title being played back.
- If the title was in the resume stop mode, the dubbing will start from the beginning to the end of the resume stopped title.
- When dubbing from HDD to DVD or VR mode DVD-RW to HDD, recording mode will automatically be set to "High" whenever the conditions are met. (See page 41.)
- If the high speed dubbing is not available, the title will be dubbed in normal speed with the recording mode of the title.
- If the title is recorded in other brand's DVD recorder, the title will be dubbed in normal speed with the recording mode that you set with [REC MODE].
- If there is not enough space left on the disc for high/normal speed dubbing with the title's recording mode, the title will be dubbed in normal speed with "Auto" mode. If there is not enough space left on the disc for normal speed dubbing with SLP mode, the title will be dubbed in normal speed with SLP mode until the space of the disc runs out.
- If you press [DUBBING HDD > DVD] on the front panel in stop mode without selecting any title, the unit will start dubbing the last title in the Original List or the Playlist. It will start dubbing the title in the Original List if the Original List was the last selected list. It will start dubbing the title in the Playlist if the Playlist was the last selected list.

### One Touch Dubbing from VCR to DVD



If you want to record a title in the videotape, press [VCR] first.

- 1 Press [PLAY ►] to start the playback of the videotape you want to dub.
- 2 Press [STOP ■] or [PAUSE II] where you want to start dubbing.
- 3 Press [DUBBING VCR > DVD] on the front panel.

The dubbing will start from there to the end.

#### To stop the dubbing in progress:

Press [STOP ■] on the front panel.

Press [STOP ■] for 2 seconds on the remote control.

#### Note

- When dubbing starts, the video image may be distorted because of the Digital Tracking function. This is not a malfunction. Play the videotape until the image clears up and then start the dubbing.
- Dubbing takes as much time as the playback does.